



VERTEX 70

● for routine to research applications



The VERTEX 70 provides the entry level of the Bruker VERTEX Series of high performance FT-IR spectrometers for demanding analytical and R&D application. The innovative instrument design results in PEAK flexibility and PEAK performance. The fully digital FT-IR spectrometer features DigiTect™ technology based on parallel running dual-channel delta sigma ADC's with 24-bit dynamic range, the ACR and AAR Automatic Components and Accessories Recognition as well as the BRAIN Bruker Artificial Intelligence Network which guarantees PEAK signal-to-noise ratio and reliable user friendly instrument operation.

● VERTEX 70

BRUKER Artificial Intelligence Network (BRAIN)

A network of intelligent functions such as recognition of sampling accessories and optical components, automatic set up and check of measurement parameters and the permanent online check of the spectrometer electronic and mechanical components makes FT-IR spectroscopy easy, fast and reliable. Specific software tools complete this outstanding functionality.

Spectral Range Extension

The VERTEX 70 can be optionally equipped with optical components to cover the entire spectral range 15 cm^{-1} to 28,000 cm^{-1} from the very far IR, through the mid and the near IR up to the visible and ultraviolet. With standard internal source and room temperature DLaTGS detector, the most interesting spectral range from 6000 cm^{-1} to 130 cm^{-1} is accessible in a one step measurement using the new and unique wide range mid and far IR beamsplitter.

Due to the pre-aligned optical components and the cube corner mirror based permanently aligned RockSolid™ interferometer, changing spectral range is a very easy task. The beamsplitters are exchanged within seconds and require no interferometer re-alignment. Two internal sources and detectors are computer controlled.

Spectral Resolution

The standard spectral resolution of better than 0.4 cm^{-1} is suitable for most measurements of solids, liquids and low temperature crystalline samples. However, should the needs of the laboratory change, the spectral resolution capabilities can be upgraded to a non-apodized resolution of 0.16 cm^{-1} which is usually sufficient even for gaseous samples at ambient pressure, because the typical natural line width is greater than 0.2 cm^{-1} .

Vacuum Optics

The VERTEX 70 is available under the model name VERTEX 70v with a fully evacuable optics bench. It is well accepted that vacuum optics provide pure IR spectra without residual moisture absorption which are of relevance for highly sensitive measurements in the mid and far IR spectral ranges. Details about the VERTEX vacuum spectrometer series are available in the related product descriptions.

Rapid Scan Kinetics

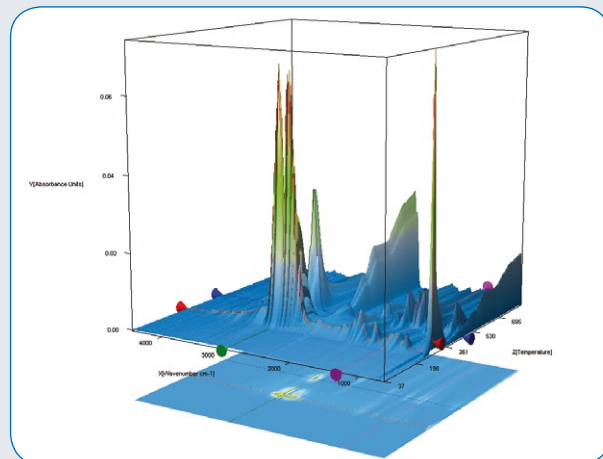

The OPUS 3D plot shows the thermal decomposition of a polymeric automobile undercoating material containing PVC. The spectra were measured on a VERTEX 70 coupled with thermal gravimetric analyser (TGA) with 4 cm^{-1} spectral resolution in time intervals of a few seconds.

Far Infrared Spectral Range

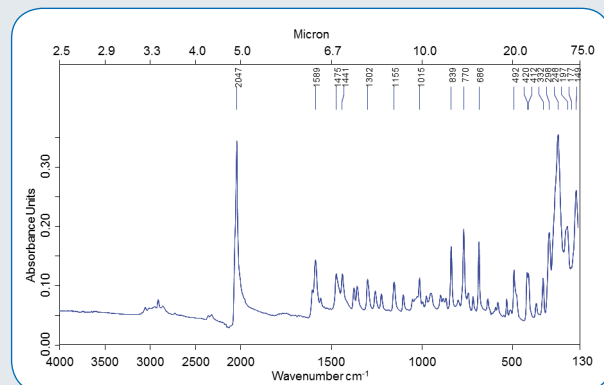

MIR-FIR spectrum of a metal complex sample measured in one go from 4000 cm^{-1} to 130 cm^{-1} using Platinum diamond ATR and purged VERTEX 70 equipped with the standard MIR source, ultra wide range far-mid IR beamsplitter and room temperature DLaTGS detector at 4 cm^{-1} spectral resolution.

Visible Spectral Range

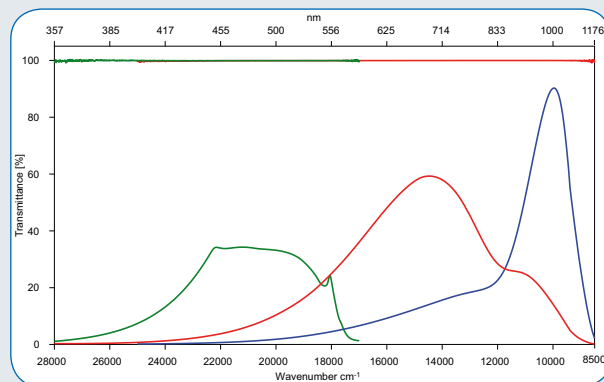

Background single beam spectra and 100%-lines measured in the near IR, visible and UV spectral ranges using 8 cm^{-1} resolution and different aperture sizes. In connection with the internal tungsten source, the NIR/VIS/UV broad band beamsplitter as well as optimized detector types and/or an optical low path filter, the short wavelength efficiency is significantly improved.

Electronics unit with LED indicators of the instrument status

Features

Ease of Use

The innovative optics design results in the most flexible and expandable FT-IR spectrometer available. With an easily maintained, sealed and desiccated optics bench, highest sensitivity in the mid- and near-IR regions is obtained on a spectrometer requiring no purge gas or cooling water. Automatic sample compartment shutters make it possible to use the sample compartment without windows, offering improved throughput and transmittance accuracy, e.g. for the measurements of optical components. The optional sample compartment telescope window inserts eliminate the purge wait time for the measurement of liquids, films or pellets especially in the far IR spectral range. Sampling accessories are mounted and pre-aligned on Bruker's QuickLock™ baseplate for fast, easy and reproducible exchange. Immediately after the sampling accessory is inserted, it is automatically recognized by the IntelliSense™ coding.

ACR: Automatic Component Recognition

The sources, detectors and beamsplitters on the VERTEX 70 are electronically coded to be recognized by the instrument and the experimental parameters are reconfigured immediately. The user doesn't need to know which parameter set to load; it's all done automatically. In addition, if two components are installed which conflict, the VERTEX 70 will recognize this, inform you about the mismatch and offer you an alternative solution. The software is even able to propose optical components for the spectral range of interest.

- Sealed and desiccated optics bench, optionally purgeable
- RockSolid™ cube corner mirror based interferometer
- Up to 5 exit and up to 2 input beam ports remotely selectable
- Options for automated internal dual sources and dual detectors
- Automatic sample compartment shutters optional
- Easy beamsplitter exchange with permanent interferometer alignment
- Wide range MIR & FIR beamsplitter covering 6000 to 10 cm⁻¹ in one step
- Near IR, visible/UV and far IR/THz spectral range extensions
- Highest sensitivity due to parallel dual channel 24-bit dynamic range ADC's
- Unique Bruker **BRAIN** spectrometer technology
- Rapid Scan, Slow Scan and Step Scan options for modulation and time resolved spectroscopy (TRS)
- Complete and integrated OPUS™ operation and evaluation software
- Availability of vacuum optics bench system VERTEX 70v

NEW

Detector compartment with selectable DigiTect positions for room temperature and LN₂ cooled detectors

Left side beam exit part

Possible positions for externally vacuum tight adapted liquid He cooled bolometer for the far IR/THz spectral ranges

Windows or automatic sample compartment shutter option

Removable sample compartment lid



Opening the top cover provides easy access to the internal components, sources, storage area and tools.

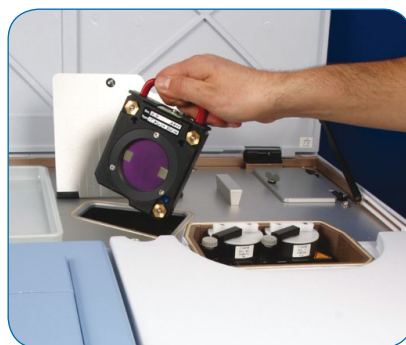

Beamsplitters are easy to exchange and can be stored inside the optics bench.



Internal detectors, such as the DigiTect™ detectors, can be exchanged easily and reproducibly by the user.

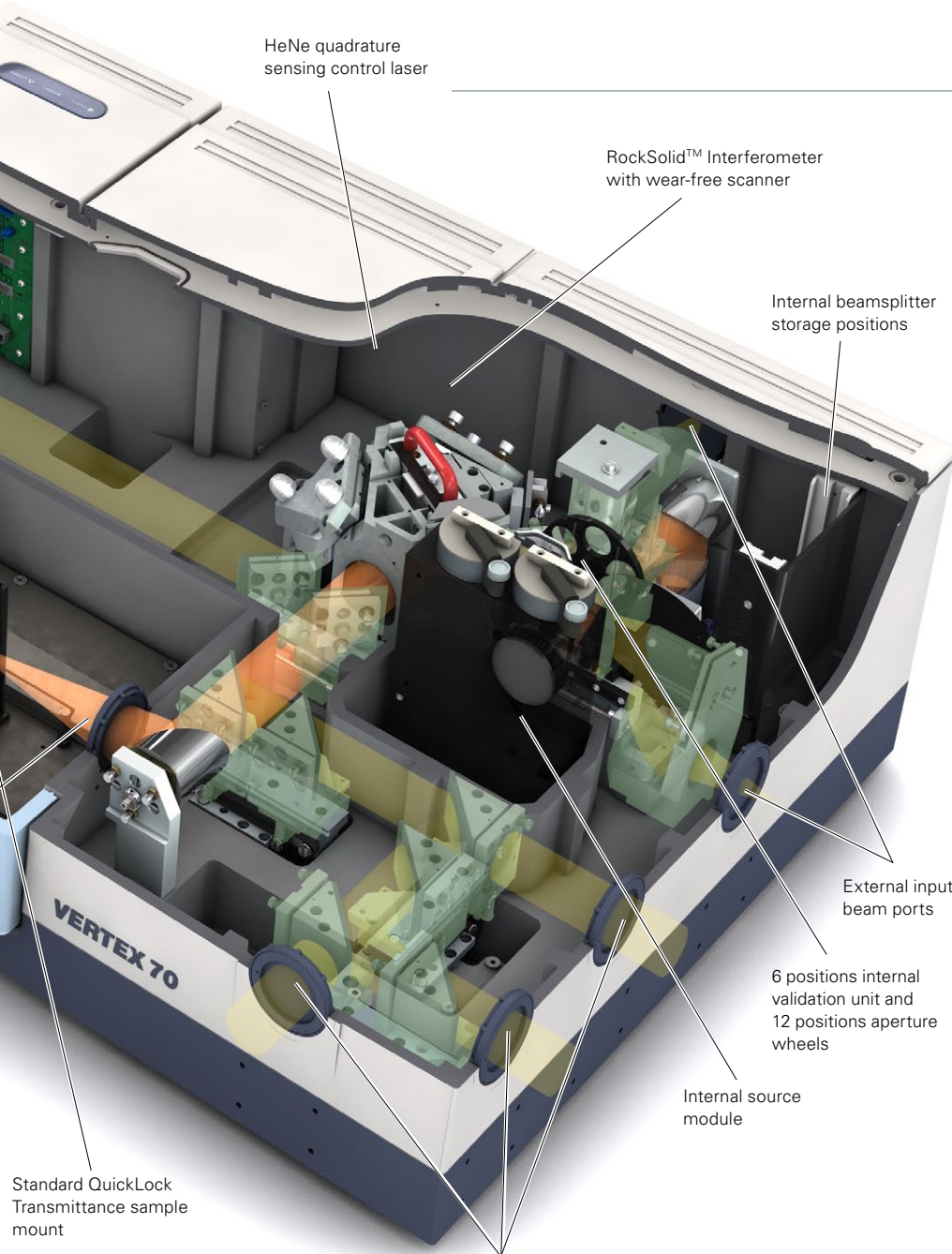

HeNe quadrature sensing control laser

RockSolid™ Interferometer with wear-free scanner

Internal beamsplitter storage positions

External input beam ports

6 positions internal validation unit and 12 positions aperture wheels

Internal source module

Standard QuickLock Transmittance sample mount

Remotely controlled beam exit ports with window flanges

DigiTect™ Detector System

Many different types of detectors are available for the VERTEX 70 FT-IR spectrometer which are based on the DigiTect™ technology. The detector housing integrates the preamplifier and the fast 24-bit parallel dual channel ADC. Photo diode type detectors feature a computer selectable preamplifier gain, providing excellent spectral detectivity at all light levels. The precise dovetail mounting enables easy detector exchange. For utmost sensitivity in the far IR or THz spectral range a liquid He cooled bolometer detector can be externally mounted and remotely selected.

Source Options

Up to two internal and two external sources are remotely selectable. Exchange of the internal source does not require breaking the instrument optics sealing or purge. The standard far-, mid- and near-IR sources are permanently operated at an optimized and constant temperature providing the best signal to noise ratio without the need for any stabilization wait time. For the extreme far IR or terahertz spectral range down to 15 cm⁻¹ or ca. 0.5THz a water cooled high temperature Hg-arc source can be mounted at one of the external input ports. Using the right side input, the source radiation is directed through the aperture and filter wheel of the instrument which is an important functionality e.g. in case the exact wavelength of quantum cascade laser (QCL) sources need to be measured.

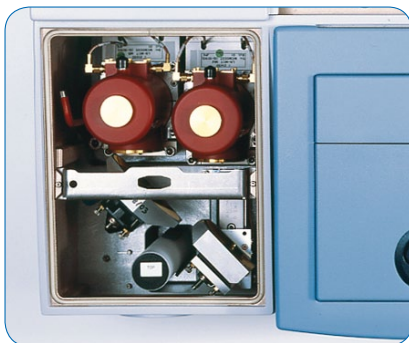

The detector compartment accommodates up to two room temperature or liquid N₂ cooled detectors.



The large sample compartment accommodates virtually any FT-IR sampling accessory.



Many external accessories, such as the TGA module, can be coupled to the VERTEX 70.

Step Scan TRS

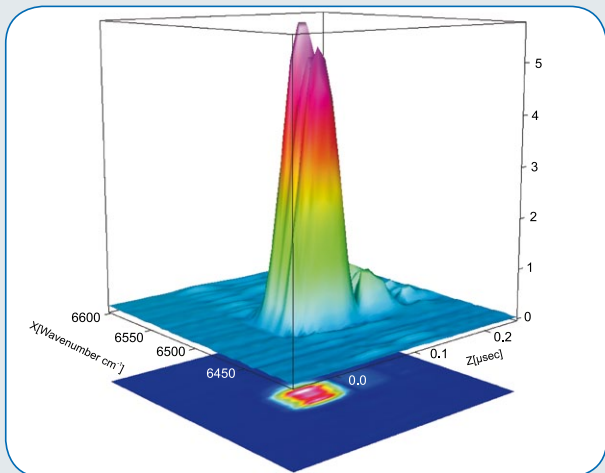

The OPUS 3D plot shows 10 nsec time resolved emission kinetics of the switch-on of a NIR laser LED at 4 cm⁻¹ spectral resolution. The data were acquired with a KBr beamsplitter and a DC-coupled photovoltaic MCT detector connected to a 100 MHz transient recorder.

Hemispherical Reflectance

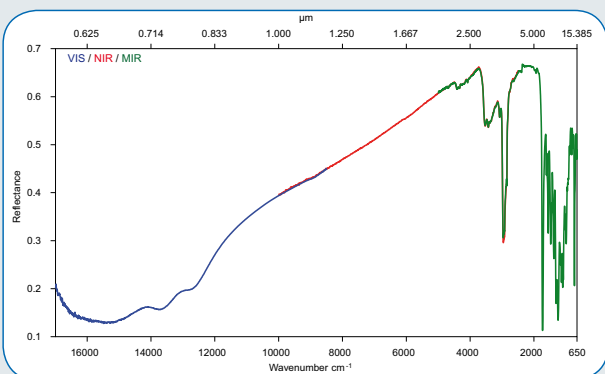

Integrating spheres allow measurement of the total hemispherical reflectance and diffuse hemispherical reflectance of rough surfaces. From such data the thermal emittance can be derived which is of particular interest for solar absorber coatings. The above spectrum of a green painted metal surface was measured by using a gold coated sphere. The perfect fit of three different spectral ranges from ca. 17,000 cm⁻¹ to 600 cm⁻¹ was achieved by automatic switching of two sources, manual exchange of two different types of beamsplitter as well as auto-switching of two detectors.

Emission Studies

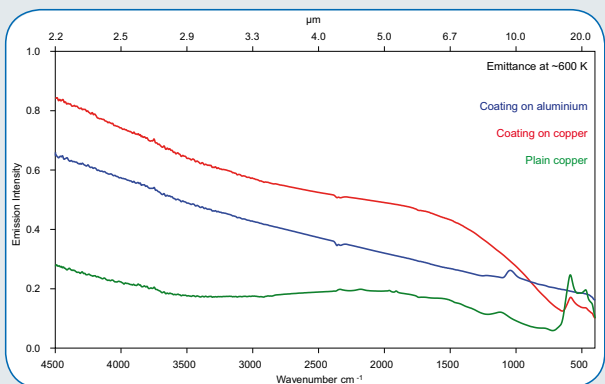

Emittance measurements at higher than room temperatures are e.g. of interest for the characterization of absorber material used for solar power plants. The above spectra show coated and non-coated metal surfaces measured at ca. 600K using the emittance adaptor A540 mounted at one of the input beam ports of the VERTEX 70 and the standard room temperature detector.

External Accessories

for Advanced Applications

The VERTEX 70 offers an extensive line of sampling accessories for the internal sample compartment for transmission, ATR, specular, diffuse reflectance and additional types of measurements. Certain applications, however, need to be carried out using accessories that can only be mounted externally, e.g. for space reasons or to keep the internal compartment free for more routine measurements. The VERTEX 70 has the flexibility in its optical layout to couple multiple external accessories, such as the RAM II FT-Raman module, a Thermo Gravimetric Analysis (TGA) system, the HTS-XT high throughput screening unit, PMA 50 photoelastic modulator accessory or HYPERION series FT-IR microscopes. Using this combination of internal as well as external accessories means that the VERTEX 70 has the power to deal with almost any analytical problem amenable to FT-IR analysis.

FT-IR Microscopy

Featuring full automation, infrared chemical imaging, crystal-clear sample viewing and a wide variety of IR and visible objectives, the HYPERION series provides you with everything needed to conduct the most sensitive micro-analysis easily and efficiently. The system allows upgrade to the fully automated HYPERION 2000 or the HYPERION 3000 hyperspectral imaging microscope with integrated Focal-Plane-Array (FPA) and single element detectors.

FT-Raman Module

RAM II is an add-on module that combines fast and easy sample handling and the excellent suppression of fluorescence offered by FT-Raman. Switching between the infrared and Raman configurations are achieved through software control. An optional FT-Raman microscope can be coupled to the RAM II module and at the same time with the SENTERRA dispersive Raman microscope.



VERTEX 70 with RAM II module

Photo-Luminescence Module

In a comparable design the PL II Photoluminescence module is available. It allows the analysis of e.g. compound semiconductor material at room or low temperatures. The PL II module is available either with visible (532 nm) or near infrared (1064 nm) internal excitation lasers. Furthermore, an optional external laser input port offers the usage of customer supplied laser sources.



VERTEX 70 with Gas Chromatograph

Hyphenated techniques

The coupling of the VERTEX 70 FT-IR spectrometer with a Thermogravimetric Analysis (TGA) system or Gas Chromatograph (GC) provides substantial additional information. For example the identification of gases released directly from the sample during a TGA run can not be performed just by thermal analysis. For that purpose the coupling with FT-IR is the ideal solution.

Similarly GC is also a widely used technique in the field of chemical analysis because it is one of the most powerful separation techniques. However, particularly for fractions with many isomeric compounds the individual molecular characterization is difficult if not impossible by the GC retention times. Again the coupling with FT-IR spectroscopy is an ideal method for on-line sample identification.

Polarisation Modulation Accessory

With new electronics and use of the delta sigma ADC technology the VERTEX 70 offers true dual channel data acquisition. This provides outstanding performance for double modulation techniques utilising a Photoelastic Modulator (PEM), such as IR Reflection Absorption Spectroscopy (PM-IRRAS) for measuring very thin films in Linear Dichroism (LD) of ordered samples and Vibrational Circular Dichroism (VCD) of optically active samples.

TGA coupling

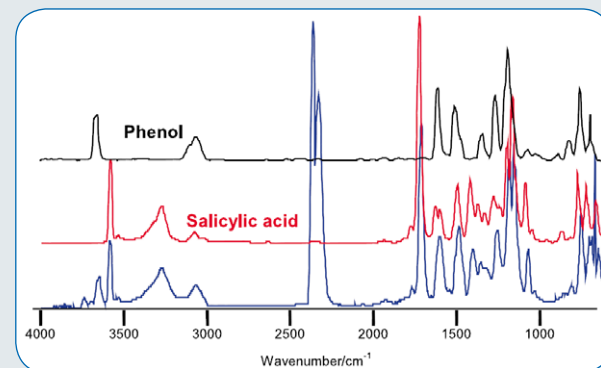

The above result shows the thermal decomposition of acetylsalicylic acid in an ASPIRIN® tablet at a temperature of 345° C versus reference spectra of salicylic acid and phenol from a digital spectral reference library. The example demonstrates that a TGA-FT-IR coupling is well suited to follow the complete decomposition steps of a pharmaceutical compound.

Beam Path Selection

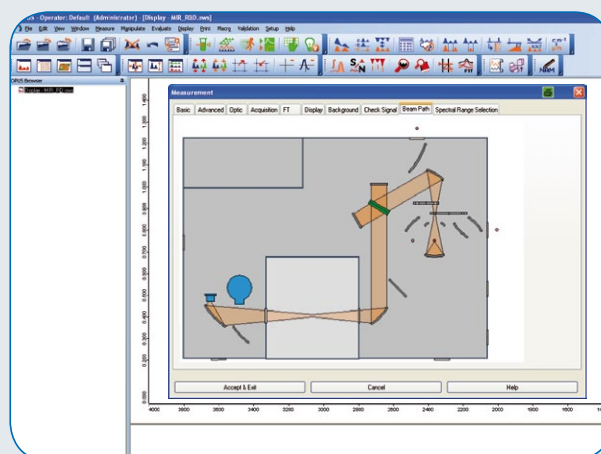

Easy beam path selection is available from the VERTEX 70 measurement software within OPUS. Just click on the required source, detector or available external beam port.

Multiple input/output ports

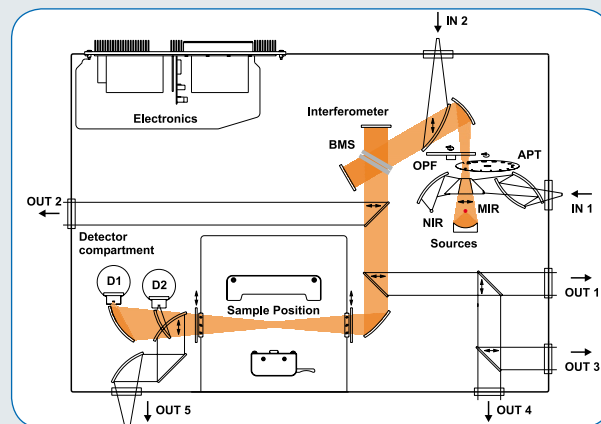

The VERTEX 70 offers outstanding flexibility. Four beam exit ports on the right, front and left side, two beam input ports on the right and rear side and one front detector port are available. This allows for e.g. simultaneous connection of an emission accessory, the RAM II FT-Raman module, a fiber optics coupling unit, a bolometer detector and the HYPERION microscope.

• Support

OPUS Software

Bruker's OPUS is an easy-to-use, powerful, all-in-one Spectroscopy software which is part of the VERTEX delivery. It includes the most comprehensive collection of data acquisition, processing, and evaluation functions optimized for applications in the fields of routine laboratory analysis, advanced R&D applications, and reaction monitoring.

The OPUS interface is completely customizable. Maybe your quality control laboratory requires restricted access to the analyzer software; or maybe you want to benefit from the flexibility and power of OPUS by granting full access for your demanding R&D applications. Either way, OPUS will meet your requirements due to its extended user management and user settings.

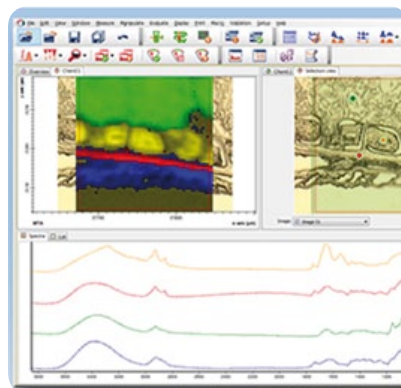

Validation Solution

Today's regulated laboratories must comply with regulatory requirements. Bruker offers comprehensive system validation manuals to provide the documentation and procedures to achieve systematic compliance.

Bruker's OPUS Validation Program (OVP) was developed to help regulated companies comply with GMP/GLP/cGMP requirements in the most cost effective manner. This OPUS package supports the automated internal validation unit (IVU), traceable standards, and Pharmacopoeia instrument qualification protocols. OVP permits combination of standards, tests, acceptance criteria, and required test interval for OQ & PQ.



Service

Bruker is staffed by expert scientists and engineers that have an in-depth knowledge of instrumentation and applications. Our product specialists will assist you in the selection and use of sampling accessories, choice of optical components and software operation. We offer customized instruction and support packages to fit your needs.

Bruker FT-IR spectrometers are designed to provide years of dependable trouble-free operation. Professional installations, comprehensive applications support as well as a high standard of post-delivery service are commitments Bruker makes to each of its customers.



Technologies used are protected by one or more of the following patents:
US 7034944; US 5923422; DE 19704598

Bruker Optics
is ISO 9001 certified.

Laser class 1 product.

www.bruker.com/optics

• **Bruker Optics Inc.**

Billerica, MA · USA
Phone +1 (978) 439-9899
Fax +1 (978) 663-9177
info@brukeroptics.com

Bruker Optik GmbH

Ettlingen · Germany
Phone +49 (7243) 504-2000
Fax +49 (7243) 504-2050
info@brukeroptics.de

Bruker Hong Kong Ltd.

Hong Kong
Phone +852 2796-6100
Fax +852 2796-6109
hk@brukeroptics.com.hk

Bruker Optics is continually improving its products and reserves the right to change specifications without notice.
© 2014 Bruker Optics BOPT-4000077-04



HYPERION Series

- FT-IR Microscopes



HYPERION stands for highest sensitivity at the highest spatial resolution in FT-IR microscopy and chemical imaging. It is designed without compromises, to combine best performance for visible inspection and infrared spectral analysis of any sample.

The HYPERION is the culmination of more than 25 years of experience in FT-IR microscopy. Its high-quality design, including all optical, mechanical, and electronic components, provides high stability and reliability. With its modular design, the HYPERION can be customized for the most challenging R&D applications. Its field of use is extremely broad and includes materials research, polymers, chemicals, forensics, art conservation, and life sciences. Featuring many contrast enhancement tools, a wide variety of dedicated objectives, and chemical imaging, the HYPERION enables you to conduct the most sensitive microanalysis easily and efficiently.

- Highest spatial resolution, limited only by diffraction of light
- Highest sensitivity even at high spatial resolution
- Attenuated total reflectance (ATR) objective with internal pressure sensor and highly accurate and stable column guidance mechanism for precise crystal positioning
- Dedicated grazing angle objective (GAO) with dual pass design for the analysis of thin layers on metallic surfaces
- Automated FT-IR mapping with all measurement modes
- All-in-one spectroscopic software for data acquisition, analysis and documentation
- FT-IR imaging with modern focal plane array (FPA) detector technology

• Sample Visualization

Visual inspection

Before any sample can be analyzed by FT-IR microscopy, the region of interest has to be located on the sample. However, many microscopic samples do not exhibit much contrast in the visible image. The HYPERION provides many different techniques to enhance the contrast for the visible inspection of the sample in transmission and reflection.

To select the most appropriate visualization for a certain sample, the HYPERION is equipped with a nosepiece and a wide variety of objectives. Contrast irises (“Köhler” aperture) are usually the first tool employed to enhance sample observation. Furthermore, rotatable polarizers are available in transmission and reflection that enable the user to distinguish samples exhibiting birefringence. For samples that mostly scatter light, dark field illumination can be applied. To visualize intrinsic fluorescence or fluorescent labels in samples, the HYPERION can also be optionally equipped with fluorescence illumination capabilities. An autofocus function is available to inspect structured sample surfaces.

Viewing devices

The CCD image of the sample is shown not only in the OPUS software on the PC, but also on a second LCD screen integrated in the microscope frame (HYPERION 2000/3000). This second LCD screen makes the sample positioning and the identification of the region of interest in the sample more comfortable. All visual images are saved with the measured infrared spectra and their specific sampling positions. Binoculars are always available on the HYPERION, providing a sample view with highest optical quality. So even on samples with very low visible contrast, the region of interest can be identified.



Contrast enhancement

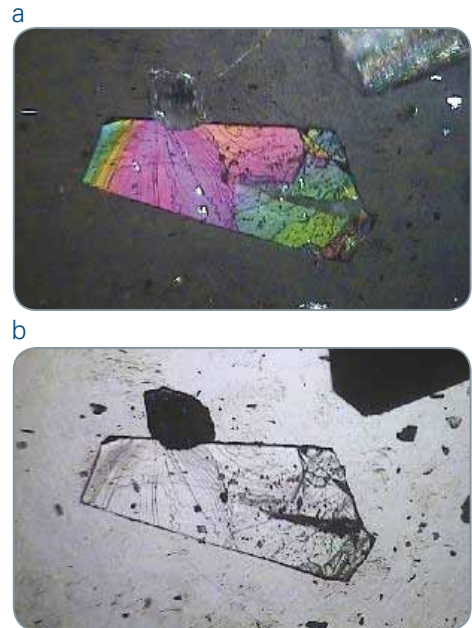

Light images of a geological sample.
a) with crossed polarizers; b) bright field

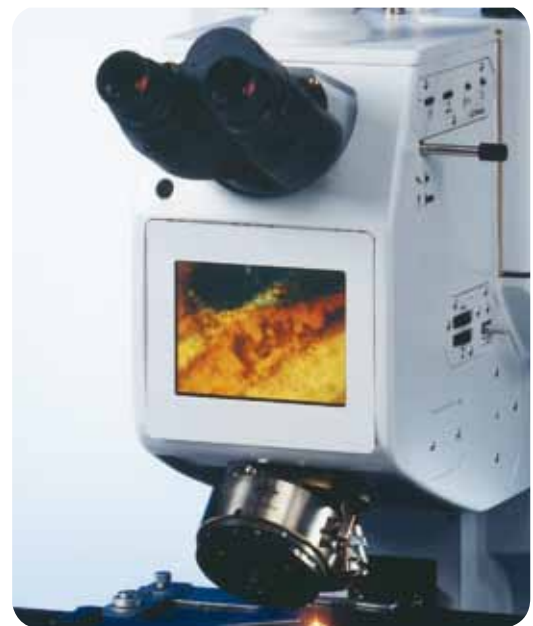

Integrated LCD screen on the HYPERION makes the sample positioning and the identification of the region of interest more comfortable.

• Sampling Flexibility

For FT-IR microscopic analysis in transmission, most samples must be optically thin and are typically cut in sections about 5–15 μm thick. If samples are deposited on reflective substrates, they are measured in reflection. However, because many samples are not transparent or reflective, they can be readily analyzed utilizing the attenuated total reflection (ATR) mode. For this reason, the quality and usability of the ATR objective is crucial for most applications. Very thin layers (even monolayers!) on reflective surfaces can be analyzed utilizing the grazing angle reflection objective (GAO).

Spectral Range

The spectral range of the HYPERION can be extended from the middle infrared to the near infrared (NIR), even to the visible (VIS, up to $25,000\text{cm}^{-1}$) and down to the far infrared (FIR, down to 80cm^{-1}). To cover this extremely broad spectral range, many different detectors are available and can easily be exchanged by the user. The HYPERION can be equipped with up to two detectors in parallel, where the switching between positions is controlled by the software.

Sample Stages

The HYPERION 1000 is equipped with a manual xy stage; the HYPERION 2000 and 3000 include a very precise and accurate motorized xy stage. Interchangeable rotatable, temperature- (-196 to $600\text{ }^\circ\text{C}$) and humidity- controlled stages are available as an option.



To investigate samples at certain temperatures from -196 – $600\text{ }^\circ\text{C}$, the Linkam THM600 stage can be used. This stage is also controlled by OPUS software.

Optical beampath of HYPERION 1000/2000

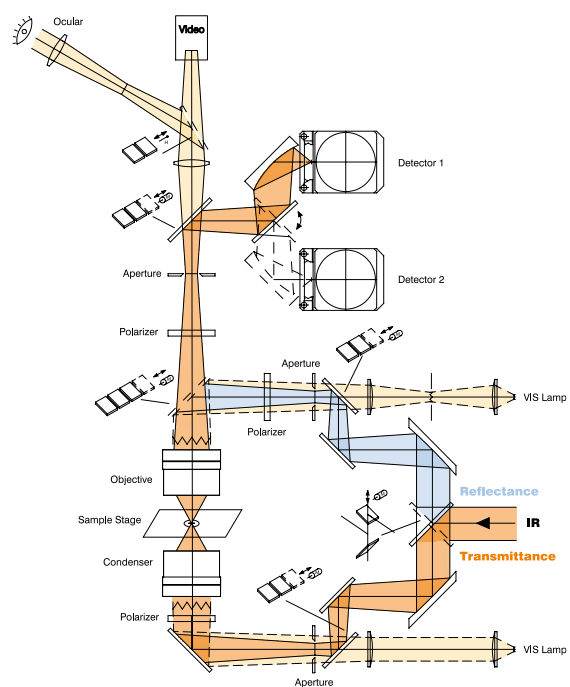

Confocal Design

The HYPERION is designed to achieve the highest sensitivity even at the highest lateral resolution. The infrared beam path is confocal. Apertures can be placed in conjugate image planes individually before and after the sample in transmission as well as in reflection. The spatial resolution for microscopic FT-IR analysis with the HYPERION is only limited by diffraction of the incident light.

In the standard configuration, the HYPERION is equipped with a single transparent knife-edge aperture. Metal knife-edge apertures, iris apertures and aperture wheels are available as well as automatic, software controlled knife-edge apertures. All types of apertures can be easily exchanged by the user.

ATR Objective

The dedicated ATR objective (20x) for the HYPERION allows clear sample viewing without sacrificing infrared light throughput. After the sample positions are defined in the visual image, the ATR crystal is moved on the highly accurate column mechanism to activate the infrared acquisition. The internal pressure sensor reproducibly ensures optimal contact between the sample and the crystal during data acquisition. In combination with the automatic z-drive (option) for the motorized xy stage, even large areas of the sample can be analyzed with high spatial resolution applying automated ATR mapping. To be useful for samples ranging from soft to very hard, different pressures can be selected at the ATR objective. ATR crystals with different tip sizes are available. They are made from materials with a high refractive index (germanium or silicon) that permit even the investigation of dark materials. Furthermore, the ATR crystal acts as a solid immersion lens so that the spatial resolution achieved with ATR is increased by a factor equal to the refractive index of the ATR crystal (germanium = 4) compared with measurements performed in transmission or reflection.

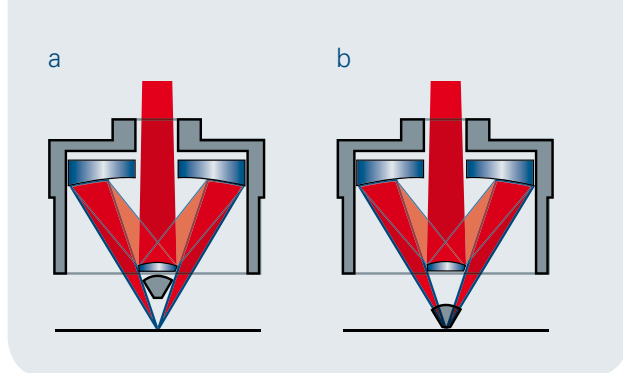

The HYPERION ATR objective has two modes of operation: one for optimal image quality in the viewing mode, and the other for providing maximum IR-light throughput. The internal pressure sensor always guarantees optimal contact between the crystal and the sample.

Grazing Angle Objective (GAO)

The measurement of very thin coatings on metallic surfaces often requires the grazing angle incidence reflection technique. It enhances the interaction of the infrared light with the sample. Bruker's patented grazing angle objective (GAO) achieves very high sensitivity due to the novel use of a folding mirror and dual pass design. The signal intensity is actually doubled during the GAO analysis because the IR beam passes through the sample twice.

Unlike other grazing angle objectives, polarization of the incident light is retained. This property facilitates selective measurements of the absorption of p- and s-polarized light, from which information about the sample orientation can be obtained.

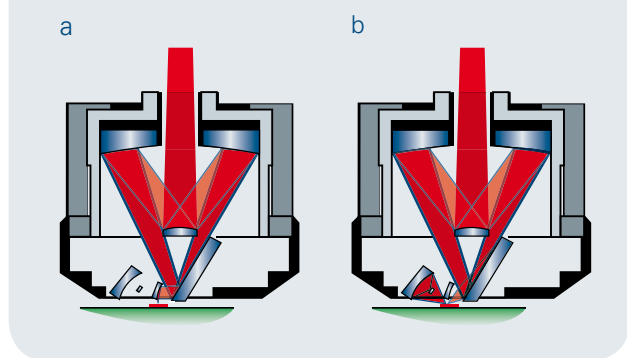

This 15x GAO objective has two modes, one for viewing the sample and the other for infrared data collection. In the viewing mode (a), two parallel plane mirrors displace the focal point to near-normal incidence, providing excellent image quality. In the IR measurement mode, the plane mirrors are moved and the IR beam is reflected on the sample surface at a high angle. After reflecting from the surface, the beam strikes a spherical mirror and is refocused on the same sample spot again before passing back into the objective.

• Chemical Imaging

Chemical Imaging

The HYPERION 3000 combines FT-IR imaging and single point spectroscopy within one microscope. This system includes modern focal plane array (FPA) detector technology utilizing the acquisition of thousands of spectra per second. Even larger sampling areas can be analyzed with highest spatial resolution very fast. High-resolution chemical images can be collected in a matter of just a few seconds. Up to 16,384 spectra can be measured simultaneously, resulting in images of up to $340\ \mu\text{m} \times 340\ \mu\text{m}$. Much larger areas are covered by assembling subsequently acquired IR images using the motorized xy-stage. Because the pixel resolution in the HYPERION 3000 is very high for all available objectives, the resolution power is only limited by the diffraction of light. A large suite of image processing functions is available in OPUS.

FT-IR microscopic imaging: Polymers

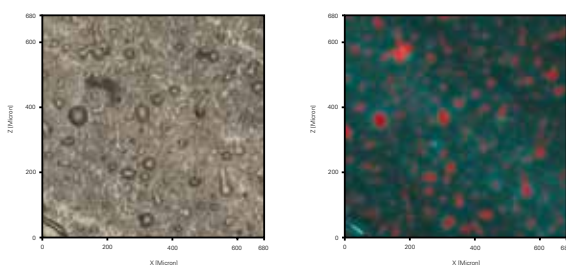

FT-IR microscopic imaging of a two-component polymer mixture spotted on a silicon substrate. The area of $680\ \mu\text{m} \times 680\ \mu\text{m}$ was measured with a pixel resolution of $2.7\ \mu\text{m}$ and a spectral resolution of $4\ \text{cm}^{-1}$ within 8 min, resulting in 65,536 spectra. Left: Visual image of the analyzed area. Right: IR image of the analyzed area showing polymer I in red and polymer II in light blue.

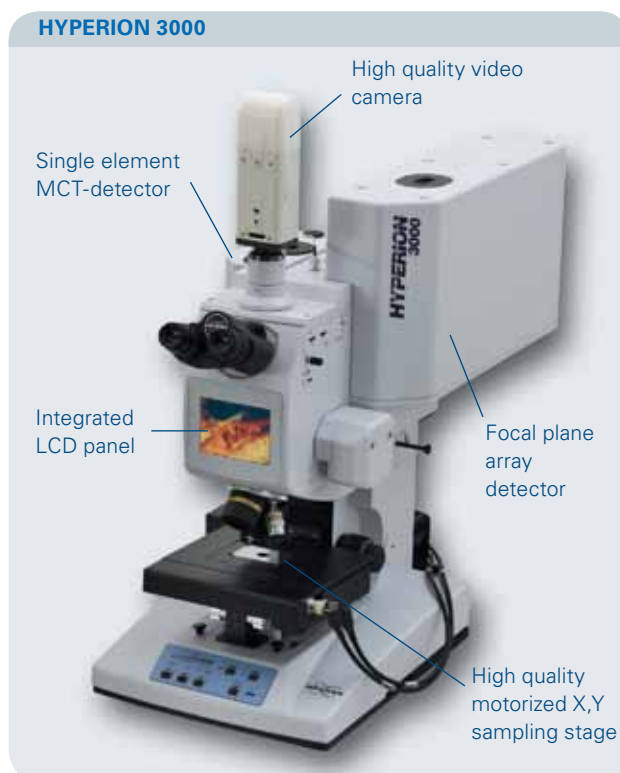

FT-IR microscope imaging: Lateral resolution

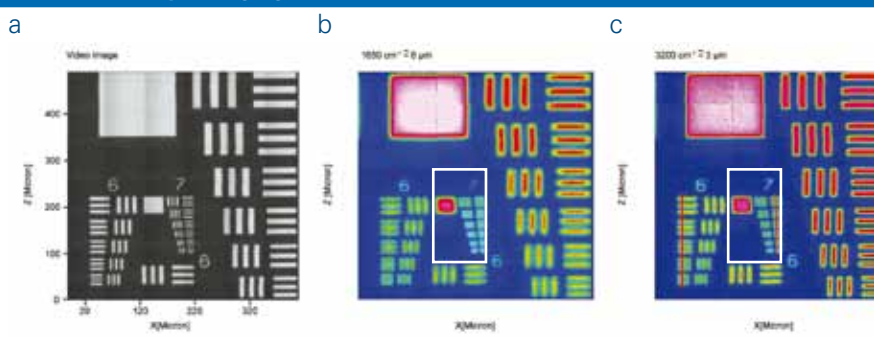

Resolution target (metal stripe pattern on glass, $400\ \mu\text{m} \times 500\ \mu\text{m}$ sampling area) measured in reflection mode with a pixel resolution of $1.1\ \mu\text{m}$ using a HYPERION 3000 with a 64×64 FPA detector and a 36x objective ($\text{NA} = 0.5$). As shown in the IR images at $1,650\ \text{cm}^{-1}$ (b) and $3,200\ \text{cm}^{-1}$ (c), the achieved lateral resolution is only limited by the light diffraction (see framed area).

• OPUS Software

The HYPERION is controlled by the OPUS software; an easy-to-use, powerful, all-in-one spectroscopy software. It includes the most comprehensive collection of data acquisition, processing, and evaluation functions. The software user interface can be customized for routine laboratory analysis as well as advanced R&D applications.

All resultant spectra, visual images, IR images, RGB and PCA plots, and annotations are stored within one file to ensure data integrity and make data manipulation straightforward.

Data acquisition using the HYPERION is very easy to accomplish, as it is guided by attractive wizards (OPUS 7.0). Many univariate and multivariate algorithms are implemented in OPUS to extract the relevant information out of the measured single or 3D data. Resulting IR images can be displayed in different 2D and 3D perspectives on top or beside the visible image.

Spectrometer Diagnostic

Only a constantly monitored spectrometer system can guarantee the acquisition of reliable data. Therefore, OPUS includes permanent online diagnostics, “real-time” display of the instrument status, and integrated automatic instrument tests (OQ, PQ). Hardware and software are fully validated.

OPUS features for FT-IR microscope and imaging:

- Wide variety of 2D/3D views for 3D and 4D data
- IR images in 2D/3D on top or next to the video images of the sample
- Calculation and visualization of RGB images, PCA analysis, 3D cluster analysis, artificial neural nets (ANN), etc.
- Correlation of 3D data with single-component spectra
- Automated mapping and imaging
- Powerful library search tools and many spectral libraries
- Many interactive functions also for 2D/3D files
- Customized workspaces

Validation

Today’s regulated laboratory and process environments must comply with extensive regulatory requirements. Providing multiple user support, electronic signature records, a high level of security, and many other required features, OPUS is a fully validated software and fulfills all 21 CFR Part 11 requirements.

ATR-microscopic mapping

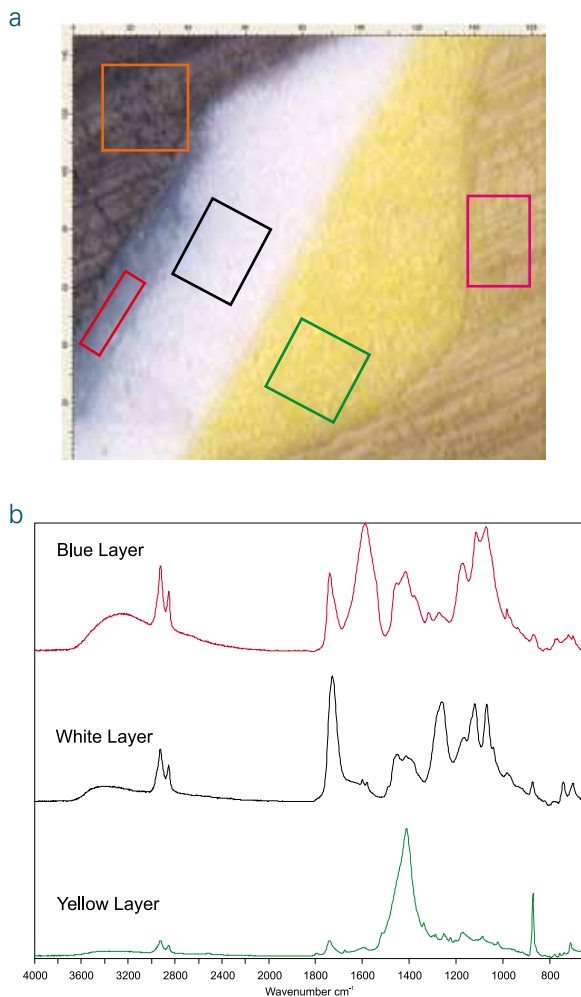

ATR microscopic mapping of a paint chip: To result in characteristic spectra for all layers, the regions of interest were defined by software first. The spectra were measured automatically with the ATR objective, whereas the sampling areas were narrowed by the motorized knife-edge aperture. Representative spectra for three layers, measured in seconds, are shown below the visible image above.

• Bruker Optics



The spectral range of the HYPERION can be extended into the VIS on one end, and to the FIR on the other end. Here, a HYPERION is shown that has a helium-cooled Bolometer for FIR measurements mounted on the second detector position.

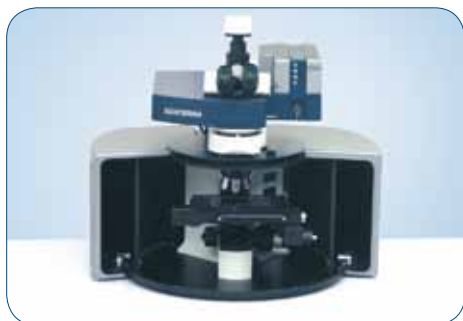

SENTERRA Raman microscope provides permanent wavelength calibration, fluorescence rejection and on-demand confocal imaging. Its open architecture allows coupling to inverse microscope, AFM and z-stage for special applications.

Support, Training, and Service

Application Support

Bruker Optics is staffed mainly by scientists and engineers with in-depth knowledge of the science and instrumentation used in the field. Our product specialists are ready to offer advice concerning the use of sampling attachments, choices of optical components, and software procedures. Furthermore, we at Bruker specialize in close cooperation with our customers in the development of spectroscopic techniques.

Training

Customer training courses are held on a regular basis for the benefit of the instrument users. Customized on-site training is also available from our staff of application specialists.

Service

Bruker Optics spectrometers are intended to provide years of trouble-free operation. Should a problem occur, a network of Bruker companies and representatives around the world is ready to respond to your needs. Professional installations and a high standard of post-delivery service are commitments Bruker Optics makes to each of its customers.

**Bruker Optics
is ISO 9001 certified.**

Lasers class 1 product

www.bruker.com/optics

• **Bruker Optics Inc.**

Billerica, MA · USA
Phone +1 (978) 439-9899
Fax +1 (978) 663-9177
info@brukeroptics.com

• **Bruker Optik GmbH**

Ettlingen · Germany
Phone +49 (7243) 504-2000
Fax +49 (7243) 504-2050
info@brukeroptics.de

• **Bruker Hong Kong Ltd.**

Hong Kong
Phone +852 2796-6100
Fax +852 2796-6109
hk@brukeroptics.com.hk