

TECHNICAL DOCUMENTATION PAGE

1. Report No. TX/99/1876-1R	2. Government Accession No.	3. Recipient's Catalog No.	
4. Title and Subtitle Use of Whole Tires and Fly Ash in Earth Retaining Structures	5. Report Date October 2000		6. Performing Organization Code
	8. Performing Organization Report No.		
7. Author(s) Priyantha W. Jayawickrama, Sadique Hossain, Taya A. Retterer	9. Performing Organization Name and Address Center for Multidisciplinary Research in Transportation Box 41023 Texas Tech University Lubbock, TX 79409		
12. Sponsoring Agency Name and Address Texas Department of Transportation P.O. Box 5080 Austin, TX 78763-5080	10. Work Unit No. (TR AIS)		11. Contract or Grant No. 0-1876
	13. Type of Report and Period Covered Deliverable #1		
	14. Sponsoring Agency Code		
15. Supplementary Notes			
16. Abstract: Finding secondary applications for used automobile tires has become a major issue because of the unique problems associated with their disposal. The vast majority of these secondary applications involve the use of waste tires in shredded form. Examples include Tire Derived Fuel (TDF) that recover energy through combustion of shredded tires, crumb rubber as a modifier for asphalt binder and asphalt concrete mix, and shredded tire as a lightweight fill material. This research examined the potential use of whole waste tires in the construction of earth retaining structures. Several retaining wall designs that incorporate waste tire as a basic structural unit are proposed. The proposed retaining wall designs involve the use of whole waste tires in a number of different forms. They are (1) whole tires filled with gravel or low strength flowable filler, (2) tires bales that are produced by compressing as many as 100 automobile tires to form a 30in x 50 in x 60 inch blocks and (3) tire bales encapsulated in a concrete casing to produce 4 ft x 4 ft x 8 ft block called Eco-Bloc®. The proposed designs include gravity retaining walls as well as mechanically stabilized earth (MSE) retaining walls. Necessary analyses have been performed to ensure adequate factor of safety against internal failure as well as external failure of the retaining wall systems. The internal stability conditions that were considered included the following: (a) rupture of the reinforcement, (b) reinforcement pullout and © bulging of the wall. The external stability conditions included: (a) sliding, (b) bearing failure, (c) overturning, and (d) global rotational stability. The analyses have been repeated for a range of wall heights, wall batter and backfill material properties to produce design charts.			
17. Key Words used tires, scrap tires, tire bales earth retaining structures		18. Distribution Statement No restrictions. This document is available to the public through the National Technical Information service, Springfield, Virginia 22161	
19. Security Classif. (of this report) Unclassified	20. Security Classif. (of this page) Unclassified	21 75	22. Price

**USE OF WHOLE TIRS AND FLY ASH IN
EARTH RETAINING STRUCTURES**

by

Sadique Hossain

Priyantha W. Jayawickrama

Research Report Number 0-1876

conducted for

Texas Department of Transportation

by the

CENTER FOR MULTICISCIPLINARY RESEARCH IN TRANSPORTATION

TEXAS TECH UNIVERSITY

October 2000

This page replaces an intentionally blank page in the original.

-- CTR Library Digitization Team

IMPLEMENTATION STATEMENT

The primary product that was developed in this research is a catalog of standard designs for earth retaining walls that use scrap tires in their construction. The catalog includes design charts for retaining walls that utilize following products as the basic structural unit: (a) individual tires filled with gravel or low strength flowable fill, (b) bales of compressed tire, (c) compressed tire bales encapsulated in reinforced concrete. The design charts have been developed for varying wall heights and batter. The charts are as well as for various loading conditions. The design charts are based on detailed stability analyses to ensure adequate factor of safety against all modes of internal and external failure. However, it is recommended that further study be undertaken to investigate constructibility and economics related to wall construction prior to field implementation.

Prepared in cooperation with the Texas Department of Transportation and the U.S. Department of Transportation, Federal Highway Administration.

AUTHORS' DISCLAIMER

The contents of this report reflect the views of the authors who are responsible for the facts and the accuracy of the data presented herein. The contents do not necessarily reflect the official view of policies of the Department of Transportation or the Federal Highway Administration. This report does not constitute a standard, specification, or regulation.

PATENT DISCLAIMER

There was no invention or discovery conceived or first actually reduced to practice in the course of or under this contract, including any art, method, process, machine, manufacture, design or composition of matter, or any new useful improvement thereof, or any variety of plant which is or may be patentable under the patent laws of the United States of America or any foreign country.

ENGINEERING DISCLAIMER

Not intended for construction, bidding, or permit purposes.

TRADE NAMES AND MANUFACTURERS' NAMES

The United States Government and the State of Texas do not endorse products or manufacturers. Trade or manufacturers' names appear herein solely because they are considered essential to the object of this report.

TABLE OF CONTENTS

LIST OF TABLES	iv
LIST OF FIGURES	v
CHAPTER	
I. INTRODUCTION	1
1.1 Overview	1
1.2 Significance of Used Tire Problem.....	1
1.3 Texas Natural Resource Conservation Commission (TNRCC) Scrap Tire Program.....	2
1.4 Current Applications of Scrap Tires.....	3
1.4.1 Energy Recovery.....	3
1.4.2 Tire Pyrolysis.....	4
1.4.3 Retreading.....	4
1.4.4 Scrap Tires in Civil Engineering Applications.....	4
1.4.4.1 Wet Poured Layers.....	5
1.4.4.2 Rubber Modified Asphalt (RMA).....	5
1.4.4.3 Marine Reefs and Shoreline Protection.....	5
1.4.4.4 Earth Retaining and Erosion Control Structures.....	5
1.5 Objectives and Scope of the Research Project.....	6
II. LITERATURE REVIEW	8
2.1 Overview	8
2.2 Tire Retaining Walls: Case Studies	9
2.2.1 ECOFLEX Retaining Systems.....	9
2.2.2 Retaining Wall at the Plumas National Forest.....	15
2.2.3 Public Works Department’s Slope Stabilization Project.....	17

2.3 Eco-Bloc in the Construction of Retaining Walls.....	19
2.3.1 Eco-Bloc	19
2.3.2 Different Types of Eco-Bloc.....	19
2.3.2.1 Bulkhead/Erosion Control.....	19
2.3.2.2 Perimeter Wall	21
2.3.3 Design Criteria	21
2.3.3.1 Design of the Unit.....	23
2.3.4 Different Applications of Eco-Bloc.....	26
2.3.5 Features and Benefits of Using Eco-Bloc™	
in Retaining Walls.....	26
2.3.6 Economics of Construction by Eco-Bloc™.....	28
2.4 Encore Tire Bales in the Construction of Retaining Walls.....	28
2.4.1 En-Core Baler.....	28
2.4.2 Summary of Test Results on En-Core Tire Bale.....	31
2.4.3 Benefits of Using Baled Whole Tires.....	31
2.4.4 Costs of En-Core Baler.....	31
2.4.5 Different Applications of Baled Tires.....	32
2.4.5.1 A Brief Description of Carlsbad,	
NM Project.....	33
2.5 Facing Materials for Tire Retaining Walls.....	36
2.5.1. Shotcrete.....	40
2.5.2. Stucco.....	40
2.5.3. Vegetative Covering.....	41
2.5.4. Geofabric.....	43
2.5.5. Concrete Blocks.....	43
2.5.6 Combinations.....	45
III. Stability Analysis and Design of Retaining Wall	46
3.1 Overview.....	46

3.2 Mechanically Stabilized Earth Tire Retaining Walls.....	46
3.2.1 Modes of Failure.....	46
3.2.1.1 External Stability.....	51
3.2.1.2 Internal Stability.....	53
3.2.2 Stability Analysis and Design of Retaining Wall ...	55
3.3 Gravity Retaining Walls.....	65
3.3.1 Modes of Failure.....	65
3.3.2 Stability Analysis.....	66
 IV. CONCLUSIONS AND RECOMMENDATIONS.....	 67
4.1 Overview.....	67
4.2 Conclusions.....	67
4.2.1 Costs.....	67
4.2.2 Constructability.....	68
4.2.3 High Volume Application.....	69
4.3 Recommendations.....	69
4.3.1 Test Wall.....	69
4.3.2 Economic Analysis	70
4.3.3 Environmental Impact.....	70
 BIBLIOGRAPHY.....	 71
APPENDIX : FACING MATERIALS.....	73

LIST OF TABLES

1.1 Texas Scrap Tire Program	3
2.1 Existing Retaining Wall Construction Using Scrap Tires	10
2.2 Engineering Properties of Single Unit-Steel Reinforced.....	23
2.3 Engineering Properties of Single Unit-Plain Concrete.....	23
2.4 Tire Retaining Wall Facing Materials/Products: Most Promising Candidates.	37
2.5 Various Types of Panels Used as Wall Facing.....	38
2.6 More Panels Used as Wall Facings.....	39

LIST OF FIGURES

2.1 ECOFLEX [®] Wall.....	11
2.2 Geo-fabric used to cover the tires.....	13
2.3 Typical Wall Section.....	14
2.4 A Tire-faced Wall in California.....	15
2.5 Geotextile Reinforcement between Tire Layers.....	16
2.6 Tire Halves Tied with Rope.....	18
2.7 Compressed Tires.....	20
2.8 Interlocking Design of Eco-Bloc [™]	20
2.9 Oblique View of Eco-Bloc Unit.....	22
2.10 Eco-Bloc Reinforcing Using Welded Wire Fabric.....	24
2.11 Eco-Bloc Reinforcing Using No. 3 Rebar.....	25
2.12 Eco-Bloc Using Plain Concrete.....	25
2.13 Walls Using Eco-Bloc Units.....	27
2.14 River Wing Dam Built Using Eco-Blocs.....	27
2.15 Tires Being Loaded in the Baler.....	29
2.16 Tires being Compressed in the Baler.....	30
2.17 Finished Bale Being Ejected From the Baler.....	30
2.18 Tire Bales as Subgrade Lightweight Fill for Road Construction.....	33
2.19 Erosion in Lake Carlsbad.....	34
2.20 Bales on top of Concrete Foundation.....	35
2.21 Encapsulation of Tire Bales in Concrete.....	35
2.22 Block Retaining Wall on Top of Bales.....	36
2.23 Shotcrete over Tires, Salt Ash, New Castle.....	41
2.24 Stucco over Concrete Blocks.....	42
2.25 Vegetative Covering of a Sound Barrier. Redhead, New Castle.....	44
2.26 Geofabric over Tires, Salt Ash, Newcastle.....	44
3.1 Mechanically Stabilized Earth Wall employing scrap tires.....	47

3.2 Typical MSE Wall Construction using Eco-Bloc Units	48
3.3 Gravity Walls made of Scrap Tires.....	49
3.4 Gravity Walls of Different Shape utilizing Tire Bales	50
3.5 External Stability Failure Mechanisms of MSE Retaining Walls	52
3.6 Internal Stability Failure Mechanisms of MSE Retaining Walls.....	54
3.7 Coulomb's Active Earth Pressure	58
3.8 Tensile Forces in the Reinforcements and Schematic Maximum Tensile Force Lines: (b) inextensible reinforcements, (c) extensible reinforcements.....	60

CHAPTER I

INTRODUCTION

1.1 Overview

Throughout the United States, millions of waste tires are being generated each year. These huge dumps of waste tires represent an enormous depot of lost energy, materials, and money. Moreover, waste tires present a number of environmental, health and safety hazards to the public and represent a serious public nuisance. While scrap tires represent only 1.8% of the total solid waste stream in industrialized countries (1), problems associated with scrap tires get a disproportionate amount of attention. The hazards most commonly posed by the unsafe disposal of scrap tires are fire hazard and mosquito breeding.

1.2 Significance of Used Tire Problem

According to the Rubber Manufacturers Association, in 1998, 270 million tires were generated in the United States. Approximately 66 percent of these scrap tires were productively used or recycled. Another 12 percent were placed in landfill or monofill. Estimates also indicate that the current stockpile of scrap tires in the US is around 400 million (1). Scrap tires create unique problems in landfill disposal, not only because of their large numbers but also because of the nature and properties of their chief component, rubber. Rubber tires are difficult to compact in landfills because they tend to rise and even pop through the groundcover as other waste materials compact around them. Their buoyancy causes them to rise to the surface after rainfall leaving behind empty spaces that damages the landfill's stable, carefully layered composition. In addition, the hollow shape of the tires fills with decomposition gases creating a serious fire hazard. Experience has shown that large tire fires can burn for weeks causing the rubber to decompose into oil, which may pollute ground and surface water, as well as gas and carbon black. Moreover, the tire rubber is a dense, durable and elastic material that does not undergo natural decomposition in landfill environment easily. Rainwater accumulates in tire piles creating an ideal environment for mosquitoes, which are known to transmit disease to humans. Because of all these reasons, many landfills do not accept large quantities of discarded tires, while others charge a high tipping fee for their disposal. Consequently, scrap tires are frequently placed in dedicated stockpiles or in illegal tire dumps.

1.3 Texas Natural Resource Conservation Commission (TNRCC) Scrap Tire Program

The majority of the States have imposed regulations that require tires to be processed (cut, sliced, and shredded) prior to landfilling. Some of the states allow storage (above ground) of shreds at landfills. In almost all States either by law or more often by adopting high disposal fees, whole scrap tires are hardly discouraged from being kept in landfills. The State of Texas had a scrap tire program managed by the Texas Natural Resource Conservation Commission (TNRCC) until December 31, 1997 (2). In 1997, the Texas scrap tire program ended leaving the scrap tire industry to follow market forces. Part of the changes made included that the waste recycling program would no longer provide free waste tire collection or reimbursement for shredding and recycling of tires. No waste tire fee would be collected by the State with the

purchase of new tires. However, generators are now free to charge a fee at their discretion to cover the cost of managing waste tires. A comparison between the previous program and the new one is presented in Table 1.1 (3).

The TNRCC currently manages the scrap tire activity in the state of Texas through a series of regulations aimed at each of the participants. These participants must comply with TNRCC requirements as well as local ordinances, which may be more stringent. The participants include generators, transporters, scrap tire facilities, storage site, and landfills. A more complete review of the current TNRCC regulations can be found in Sonti, 1999 (5).

Table 1.1 Texas Scrap Tire Program (3)

Until December 31, 1997	After January 1, 1998
Consumers pay a fee with the purchase of new tires	No waste tire fee will be collected by the tire dealer and sent to the Comptroller's Office. Tire dealers may charge a fee at their discretion.
Generators receive free collection of waste tires.	No free collection of waste tires. Generators must pay for disposal.
Tires prohibited from landfills	Tires can be disposed in landfills if split, quartered or shredded.
TNRCC registers transporters, processors, storage sites, recycling and energy recovery facilities	No change
Manifest system used to track disposal to enforce against illegal disposal by generators and transporters	No change
Illegal site (Priority Enforcement List - PEL) cleanup suspended until September 1, 1997 then sites will be remediated using competitive bids.	PEL site clean up awarded through competitive bids. New sites will be referred to enforcement.
Reimburse processors \$ 0.80 per tire for collection, shredding and recycling. Reimburse energy recovery facilities \$ 0.80 per tire for burning whole tires and \$ 0.40 per tire for burning shreds.	No reimbursements by TNRCC.

1.4 Current Applications of Scrap Tires

Presently, approximately 66 percent of scrap tires are being used in retreading, recycling, and energy recovery applications or in Civil Engineering applications (1).

1.4.1 Energy Recovery

Tires can be burnt for energy recovery. Tires are burned for fuel in power plants, tire-manufacturing plants, cement kilns, pulp and paper plants and small steam generators utilizing a combustion technology similar to that for coal. In the U.S., approximately 114 million scrap tires were used as fuel supplement in power plants, cement kilns, industrial boilers, etc., in 1998 (1).

Tire Derived Fuel (TDF) is currently the most widely used disposal method for scrap tires. TDF is defined as a scrap tire that is shredded and processed into a rubber chip with a range in size and metal content. Size normally varies in a range of 2 inches to 4 inches and metal content ranges from wire free, to relatively wire free, to only bead wire removed, to no wire removed (1). Depending on the amount of wire removed, the TDF has an energy content ranging from 14000 Btu/lb. to 15000 Btu/lb (5). Combustion efficiency for TDF is generally understood to be in the 80% range (6). Hence, the re-use of scrap tires as tire derived fuel is generally considered to be one of the more promising approaches to solve the scrap tire disposal problem.

1.4.2 Tire Pyrolysis

Pyrolysis is the thermal decomposition of an organic material under the exclusion of ambient oxygen. The typical products of scrap tire pyrolysis are: hydrocarbon gases and oils, low-grade carbon black and steel. Pyrolysis plays only a marginal role in the scrap tire industry because the oil and gas produced in this method needs to compete with the low prices of conventional fuel.

1.4.3 Retreading

One form of tire recycling that has been in use for many years consists of tire retreading. But available data indicates that retreading of old tires for reuse has steadily declined in the US, particularly in the recent years. The decline in retreaded tire market has been partly attributed to the complex technologies used in the production of modern, high quality tires. As a result, the retreading of tires with new designs has become a less profitable business.

1.4.4 Scrap Tires in Civil Engineering Applications

Scrap tires are used in different ways in Civil Engineering Applications. Civil Engineering projects utilizing scrap tires typically involve replacing conventional construction material (e.g. road fill, gravel, sand or dirt) with whole scrap tires or tire chips. In their whole form, tires are used in crash barriers, reef, shore protection and in retaining walls. Whole tires are now being used to prevent soil erosion. Tires are also used as fill. Crumb rubber is being used in highway applications including the improvement of asphalt.

1.4.4.1 Wet Poured Layers

Playgrounds and athletic surfaces are frequently covered with a layer of rubber granules in order to help prevent injuries. Many high schools throughout the U.S. use running tracks that consist of recycled material. Most commonly, a moisture-curing urethane is mixed with ground tire rubber (GTR) and applied in a similar way as other poured pavements. These layers are usually softer than molded mats and the top layer can be colored.

1.4.4.2 Rubber Modified Asphalt (RMA)

Adding recycled tire rubber to the hot asphalt mix is a very economical way of meeting, or exceeding, the new SHRP specifications that require certain physical properties that rarely can

be met by conventional (unmodified) asphalt cements. RMA can significantly widen the temperature span of asphalt pavements when compared to conventional asphalt binders. Increased resistance to rutting, reflective and thermal cracking are the main benefits of RMA. Other advantages include better de-icing properties, reduced traffic noise and, most importantly, a significantly increased service life and thus a lower life cycle cost.

1.4.4.3 Marine Reefs and Shoreline Protection

Artificial reefs are used in the marine environment to duplicate conditions that cause concentrations of fish and invertebrate on natural reefs. Scrap tires have been used for shoreline protection since the 1970's. Breakwaters are offshore barriers that protect a harbor or shore from the strong impact of waves. Scrap tires for breakwaters and floats are filled with material, usually foam, which displaces water.

1.4.4.4 Earth Retaining and Erosion Control Structures

Whole scrap tires have been used in a variety of earth retaining and erosion control structures across the world. Some of these structures have used whole tires filled with soil or gravel as the basic building unit. Some others have used baled tires that are produced by compressing a large number of tires and binding them together. One example of such earth retaining structures includes retaining walls for erosion control using Eco-Bloc units made by Ecological Building Systems. Another instance of tire bale use is erosion control and dam construction using En-Core baler, a tire baler produced by ENCORE SYSTEMS, inc. Some examples of earth retaining structures using whole scrap tires include: (a) ECOFLEX tire retaining wall system developed by SULCAL Construction Pvt. Ltd., in Australia; (b) USDA tire-faced reinforced earth retaining wall; (c) ECOWALL highway noise barrier in Vienna, Austria; and (d) Santa Barbara Public Works Department's earth retaining structure.

1.5 Objectives and Scope of the Research Project

Although earth retaining structures have been built using discarded tires by a number of agencies as isolated construction projects, general design guidelines applicable for a wide range of wall heights, wall configurations and backfill material types are not available at the present time. The primary objective of this research project is to develop such guidelines so that used tires and tire bales can be utilized in routine retaining wall construction projects by the transportation industry. Such retaining walls should be capable of withstanding lateral earth pressures from the soil backfill as well as any surcharge loads that is typically found in an urban setting. It is equally important that the wall, once completed, has an aesthetically pleasing appearance.

The general research approach used to accomplish the research objectives stated above consisted of the following steps:

The research approach used to accomplish the objectives stated above consists of following essential steps.

- a. As a first step, collect information on previous tire retaining wall projects. This information will include: tire retaining wall configurations, designs, equipment requirements and any specific problems encountered.

- b. Secondly, review and analyze the information collected and hence come up with a number of tentative designs that will meet needs of the transportation industry, especially TxDOT (the sponsor agency of the project).
- c. Perform necessary analysis to ensure that the selected tire wall designs have adequate factor of safety against potential modes of failure. Such analysis will examine external stability conditions that must be investigated include: sliding, overturning, and bearing failure whereas internal stability conditions include: rupture of backfill reinforcement, reinforcement pullout and bulging of the wall.
- d. Perform repetitive design calculations for walls with varying configurations, heights and backfill material properties and loading conditions and hence develop design charts.
- e. Review and identify suitable types of decorative finishes that may be used with the proposed tire walls to give the finished tire-retaining walls aesthetically pleasing appearance.
- f. Finally, establish procedures to be used in the construction of the retaining walls. These include procedures to be used in the connection of adjacent tires, connections between individual layers of tire as well as connection of backfill reinforcement to the wall facing.

CHAPTER II

LITERATURE REVIEW

2.1 Overview

This project involved a survey of different Civil Engineering applications of waste tires throughout the world. The survey included a comprehensive library search, a telephone survey and an Internet search. The primary purpose of the search was to identify some suitable techniques to build retaining walls utilizing scrap tires and tire bales. Retaining walls and erosion control devices have been constructed using tires as individual units in the states of California and Minnesota and in countries such as Taiwan, Indonesia, Austria and Australia (7,8,10,12). The California Office of Transportation Research designed and tested several erosion control applications of scrap tires (7). They found that tires used in combination with other stabilizing materials to reinforce an unstable highway shoulder and to protect a channel slope, proved to be a sound and economical alternative. Construction costs were reduced from 50 to 75 % of the lowest cost alternatives such as rock, gabion, (wire mesh/stone matting), or concrete. Also, in California the Forest Service constructed a tire-faced earth-reinforced wall. In Australia, SULCAL Construction Pvt., Ltd. has patented a process for constructing retaining walls using individual tire units. Noise barriers for highways are being built in Austria with scrap tires that are filled with plants to make them aesthetically pleasing. Indonesia has also used tires in conjunction with woven geofabric into to provide support to a hill slope. Retaining walls and River Wing dams have been built utilizing compressed tire bales named Eco-Bloc. Retaining walls for erosion control have been built using tire bales produced by Encore Systems, Inc. The findings of the literature survey are presented in this chapter.

Once a tire wall is constructed there is frequently a need to improve the appearance. In order to accomplish this, several different types of facing materials can be employed. Facing materials can be as simple as a vegetative or geotextile covering to as complex as shotcrete or paneling.

2.2 Tire Retaining Walls: Case Studies

Several retaining wall systems already on the market and are summarized in Table 2.1. Three systems have been chosen for an in depth review. These systems have been chosen for their possible value to Texas Department of Transportation.

1. ECOFLEX[®] Tire Retaining Wall Systems
2. Public Works Department's slope stabilization project at Santa Barbara, California.
3. Retaining Wall at the Plumas National Forest in California, built by the U.S. Forest Service. These designs are discussed below in detail.

2.2.1. ECOFLEX[®] Retaining Systems

ECOFLEX is a patented design of the Australian based, SULCAL Construction Pvt. Limited. This design uses whole waste truck tires to construct retaining walls as shown in Figure 2.1 (8,9). They can be constructed to satisfy a variety of requirements. These walls were found

to be structurally safe for heights up to at least 3m (approximately 10 ft) and it is assumed that greater heights can be reached. This type of wall could be a gravity wall, a reinforced earth type wall or a wall with tiebacks. It can be built at varying angles, batters or steps. It is suggested that if a wall of about 20 feet or more is required, then it should be constructed in steps. Based on the results from tests performed on a wall with 2.75m height by 11.3m width (with a 1 in 5 face slope), it was suggested that the ECOFLEX[®] retaining wall system was safe for heights up to at least 3m (10 ft).

Table 2.1 Existing Retaining Wall Constructions Using Scrap Tires (4)

Case study	Remarks
ECOFLEX [®] tire Retaining wall systems	Designed and built by SULCAL Construction Pvt. Ltd., walls can be built at varying angles; Erected in reinforced earth; Full scale tests conducted; Maximum surcharge of 83.5 kPa applied; Life expectancy of 100 years, provided tires are not subjected to combustion.
Tire-faced earth-reinforced wall, built by USDA, Forest service, Northern California	10 ft high wall, 1H:4V face batter used; soil reinforcement with slit-film geotextile used at 19 to 38 cm vertical spacing; Tires filled with local backfill; Tires staggered one-half diameter for each successive layer; face settlement of 1 ft measured after 5 years.
Granite aggregate filled rubber tire retaining wall, Batam, Indonesia	7 ft high wall to support a hill slope adjacent to a 328 ft high microwave transmission tower; rubber tires filled with granite aggregates and quarry waste; Woven geofabric to resist lateral earth pressure.
ECOWALL highway noise abatement barrier, Vienna, Austria	Designed and built by Econtract company in Austria; Tire cavities filled with earth; Tires are perforated and planted with creeping vines or other local flora.
Reinforced-earth tire retaining wall, Santa Barbara, CA	Whole tires used to construct wall face; Tires were split into two along the treads and used for soil reinforcement; Tire halves were anchored into backfill using rebars; Tire halves were also tied to each other using ropes; Cost around \$27 per sq ft.



Figure 2.1. ECOFLEX[®] Wall (8)

The basic construction of an ECOFLEX retaining wall uses whole waste tires (1030mm diameter by 230mm depth), whose topside wall is cut and removed. These tires are then filled with cobble material. A fire resistant geofabric is then used to cover the exposed portion of the tires as shown in Figure 2.2. The entire wall is covered with facing elements ranging from vegetated facing, fire resistant geofabric, sheeting, timber or concrete panels, textured surfaces and shotcreting. In reinforced earth fill walls, looped ECOFLEX[®] rubber strips are used to pass through the rear of the tire facing units as shown in Figure 2.3. The wall is constructed of truck tires in a stretcher bond formation. That is, each course was offset one half tire diameter from the course below and the tires were filled with 75mm-cobble material. As the tires are placed and filled, a backfill of the same cobble may be placed behind the tires. A slope of 1 in 5 would provide minimum loss of usable area and enhance the wall stability. A slope of this magnitude also keeps the backfill from falling through the tires. The exposed tires are covered up with a fire resistant geofabric and a second layer of geofabric is used to provide a pleasing appearance. Cobbles of about 20mm size may be used as a drain (300mm wide) when placed in a layer between the tire courses. The bottom course of tires is entirely confined in the foundation material, which can be the existing soil.

Testing was performed on a wall of 2.75m height by 11.3m width wall (with a 1 in 5 face slope) and the results show that the factors of safety against overturning, base sliding, bearing failure and internal shear failure are satisfactory (9). The ECOFLEX[®] system is designed so that only the front portion of the wall is initially exposed. The fire-resistant geofabric cover around this portion reduces the possibility of a fire. The remaining portion of the tires, being rock filled and buried, have a smaller chance of fire due to de-oxygenation. The

life expectancy of such a wall is predicted to be well in excess of a hundred years. The ECOFLEX[®] wall costs less than a conventional concrete retaining wall.



Figure 2.2. Geo-fabric used to cover the tires (8)

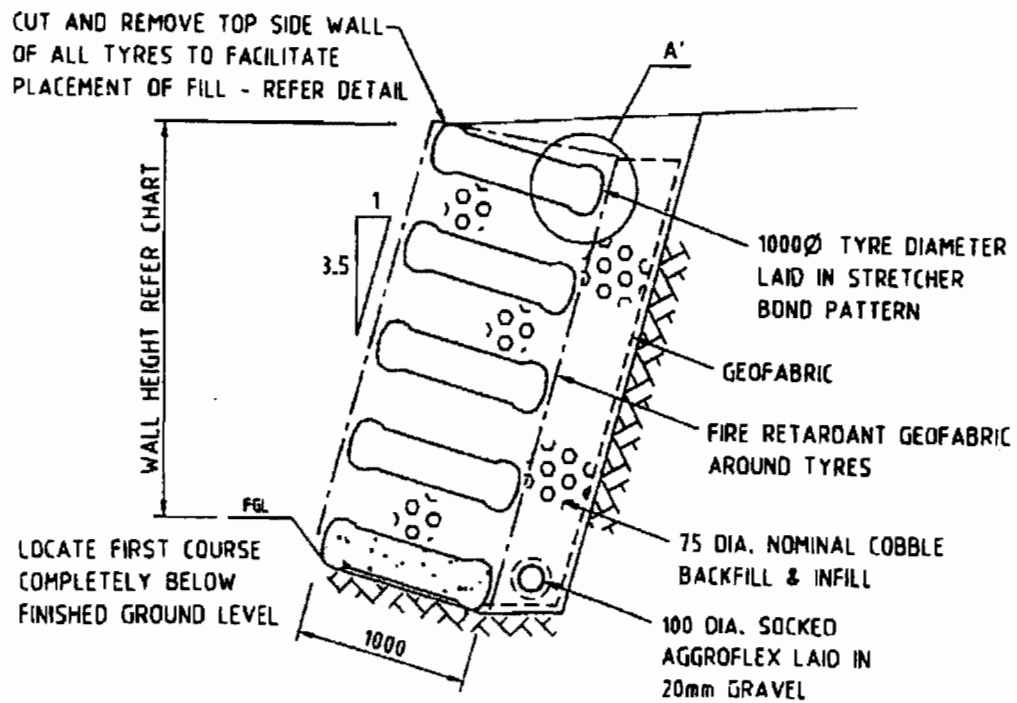
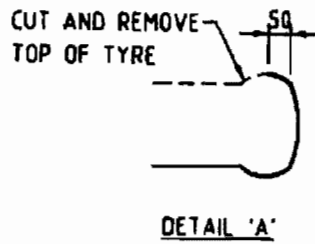

Figure 2.3. Typical Wall Section (9)

2.2.2. Retaining Wall at the Plumas National Forest

The U.S Forest Service managed over 250,000 miles of roads throughout America's national forests. When it comes to supporting these road systems, the Forest Service employs innovative ideas in design and in the use of new materials. One such idea is the use of tire-faced walls. These walls provide an attractive appearance, but are texturally interesting to see. At the Plumas National Forest in California, a 10-foot height reinforced wall was built with a tire facing and silt-film woven geotextile reinforcement (Figure 2.4).

The Plumas National Forest wall was constructed using layers of geotextile with a 15-inch vertical spacing and rows of staggered tires embedded in the front edge of the fabric. Two rows of tires are located between fabric layers (Figure 2.5). The wall consists of 16 layers of tires with compacted soil lifts of 7 to 8 inches. The existing local material was used as the hand compacted backfill. The wall had a 1 to 4, horizontal to vertical, face batter and the tires were staggered horizontally to prevent the backfill from falling through the hole in the tires and the spaces between the tires. An additional offset would have enabled the planting of vegetation in the empty spaces. Lightweight equipment, when used for backfill compaction, did not cause tire movements. In order to avoid movements from heavier equipment, a layer of fabric threaded through the tire hole and buried in the backfill may be used.



Figure 2.4. A Tire-faced Wall in California (7)

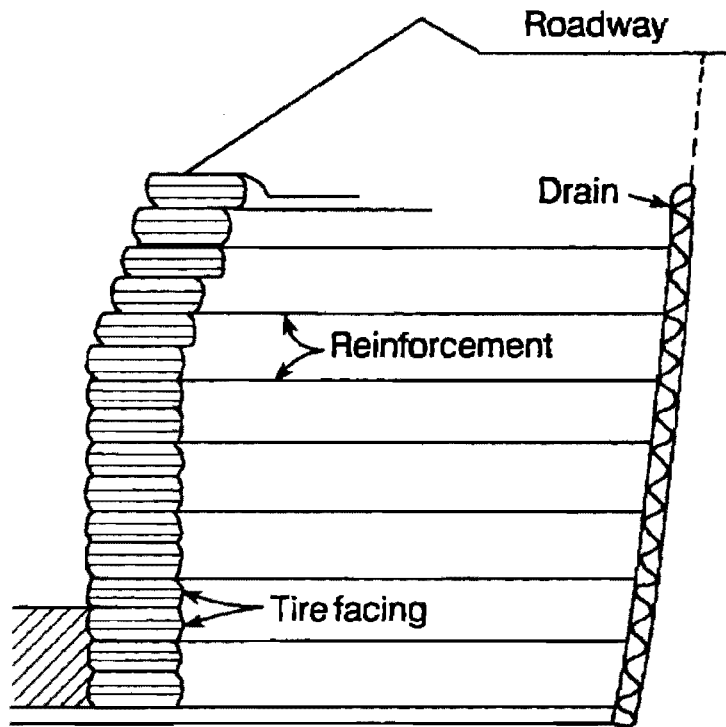

Figure 2.5. Geotextile Reinforcement between Tire layers (7)

This wall was monitored for two years for any settlement that was likely to arise, but there was little deformation. The top row of tires settled about 10% of the wall height (approximately 1-foot). However, lateral movement of the tires and long term settlement of the tire face are potential problems.

Due to the abundance of waste tires and the relatively cheap geotextiles, tire faced walls cost about \$13 per square foot of face, including the installation of a drain. This type of wall may be used in places where heights of 10 to 15 feet are required and where aesthetic appearance is not of importance. For good appearance, these walls may be covered with suitable facing material.

2.2.3. Public Works Department's Slope Stabilization Project

The Public Works Department's slope stabilization project was undertaken to replace a section of road washed away by landslides. The site has a history of soil erosion problems. The Public Works Department of the county of Santa Barbara used half tires for slope stabilization. Accordingly, the tires were first cut in half along the tread creating a total of 350 tire halves, so that the sidewalls could be used in the soil fill. The problem was approached by cutting two flat temporary benches into the slope below the road. The tires were laid out in rows on the temporary benches. Each row was anchored with rebar and strapped together with rope (Figure 2.6). The tires were tied together in several directions to form an interlocking structure, in order to increase the tensile strength. Each row of tires was covered with a 1.5 to 2.5-foot thick layer of soil, which was compacted to about 90% relative density. Layers of tires and soil were constructed in an overlapping terrace arrangement, up to the grade of the road. Finally a wall of

whole tires was placed on the slope face to resist erosion during severe periods of rainfall. The cost of such a project would be about \$27 per square foot. The existing construction has not displayed any problems. The appearance of this type of a wall is not very pleasing, so, facing material could be used to improve the appearance.



Figure 2.6. Tire Halves Tied with Rope (14)

2.3 Eco-Bloc in the Construction of Retaining Walls

2.3.1 Eco-Bloc

Eco-Bloc is a trademark of Ecological Building Systems (EBS), which is headquartered in Cypress, Texas. EBS has developed a patented process for using a bale of compressed scrap tires as a core for a structural concrete building product called the Eco-Bloc.™ It has been designed and manufactured for Civil Engineering applications like erosion control, retaining walls, border walls, prison walls, river wing dams, etc. Eco-Bloc™ is an integration of baled compressed tires with concrete and reinforcement steel to form a sealed concrete unit. The compressed tires are encapsulated with the concrete to form the central core of the blocks. Figure 2.7 shows the core of the block made by the compression of tires. It is designed with an external interlocking system to enhance structural wall strength and to simplify and reduce the installation time. The external interlocking design of Eco-Bloc™ is shown in Figure 2.8.

2.3.2 Different Types of Eco-Bloc (10)

2.3.2.1 Bulkhead/Erosion Control

The bulkhead/erosion control Eco-Bloc™ dimensions are 4'×4'×8', weighs approximately 5.5 tons, and has the equivalent structural integrity as a solid concrete block. Figure 2.9 shows the oblique view of a 4'×4'×8' Eco-Bloc unit. The economic as well as environmental advantage of building with the Eco-Bloc™ is that it contains 120 scrap tires (1 ton of waste material), which displaces approximately 52% of the concrete cost. EBS makes the Eco-Bloc™ flexible as the size, shape and structural integrity to meet project specifications and it can be manufactured at the construction site. This product can be used for building retaining walls.

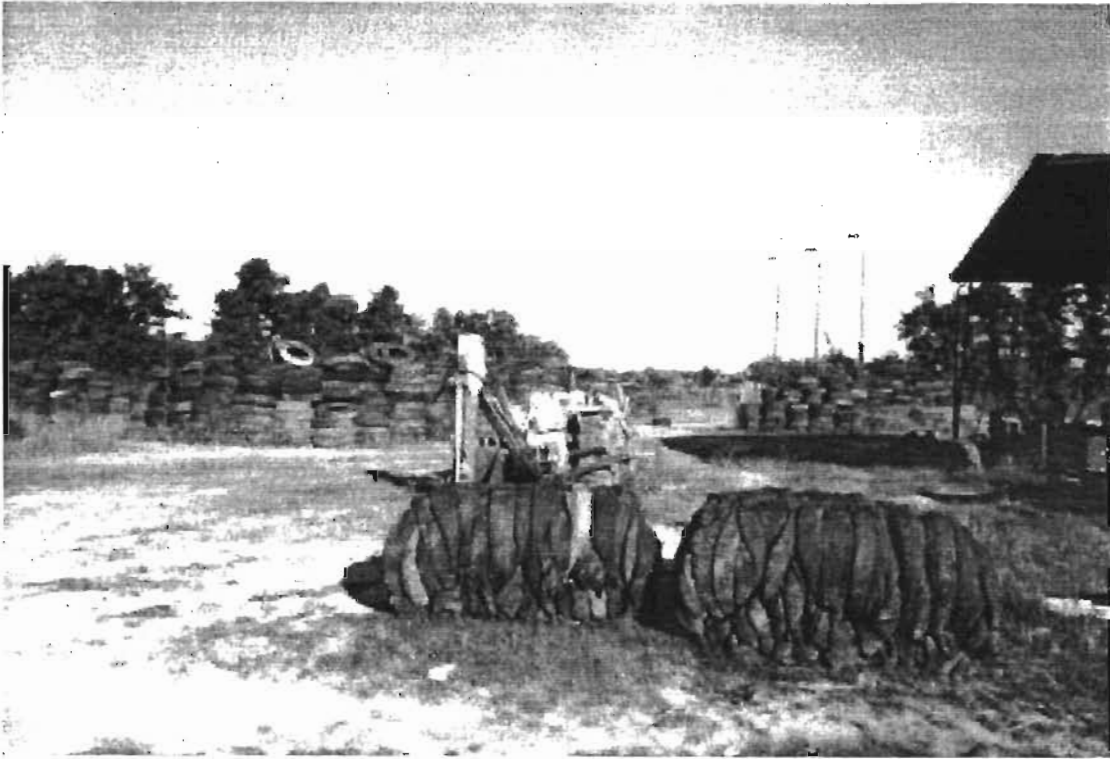

Figure 2.7: Compressed Tires (10)

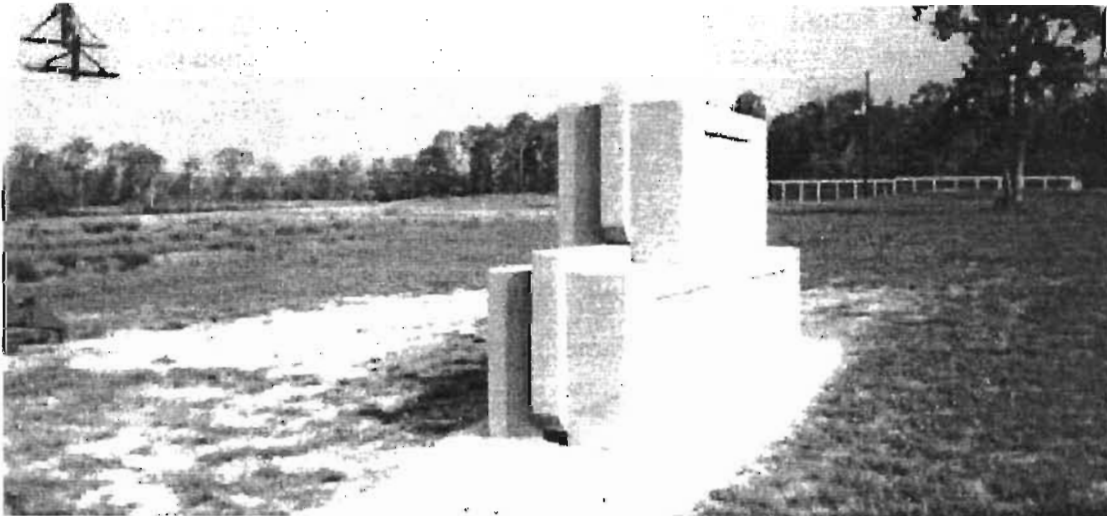

Figure 2.8: Interlocking Design of Eco-Bloc™ (10)

2.3.2.2 Perimeter Wall

The tilt wall style Eco-Bloc™ can be used for walls, barriers, security enclosures, etc. It is 2'×8'×10' in size and can be installed in the horizontal or the vertical position. EBS makes available over 30 standard architectural patterns for the exposed surface of the block.

2.3.3 Design Criteria (11)

The Eco-Bloc™ design is based on the engineering concept of weight combined with a tongue and groove system for lateral resistance. The tongue in the concrete block provides automatic alignment of the blocks, which in most cases, eliminates the need for mortar. Each segmental structural unit serves as a gravity structural element for walls, structures, and a permanent erosion control unit. The basic unit has a minimum wall thickness of 6 inches with a central core of recycled tires. The overall design configurations include the following.

- Unit geometry,
- Loading,
- Location(dry/wet).

Two units are available; a steel reinforced unit for structural applications and a plain concrete unit for non-structural applications. The basic unit is manufactured using 3000-psi concrete and has a minimum wall thickness of 6 inches with a central core of recycled tires.

Table 2.2 is presented to provide basic engineering data for a single containment unit, meeting minimum reinforcing requirements of the American Concrete Institute (ACI), ACI 318-89 (revised 1992) specifications. The use of this data will allow an engineer to design a wall system for site-specific conditions. A qualified engineer should review any proposed application to be certain that the actual site conditions and the proposed dimensions meet with standard engineering practice.

Table 2.3 provides engineering data for a single containment unit consisting of plain concrete. This unit shall not be used in structural applications.

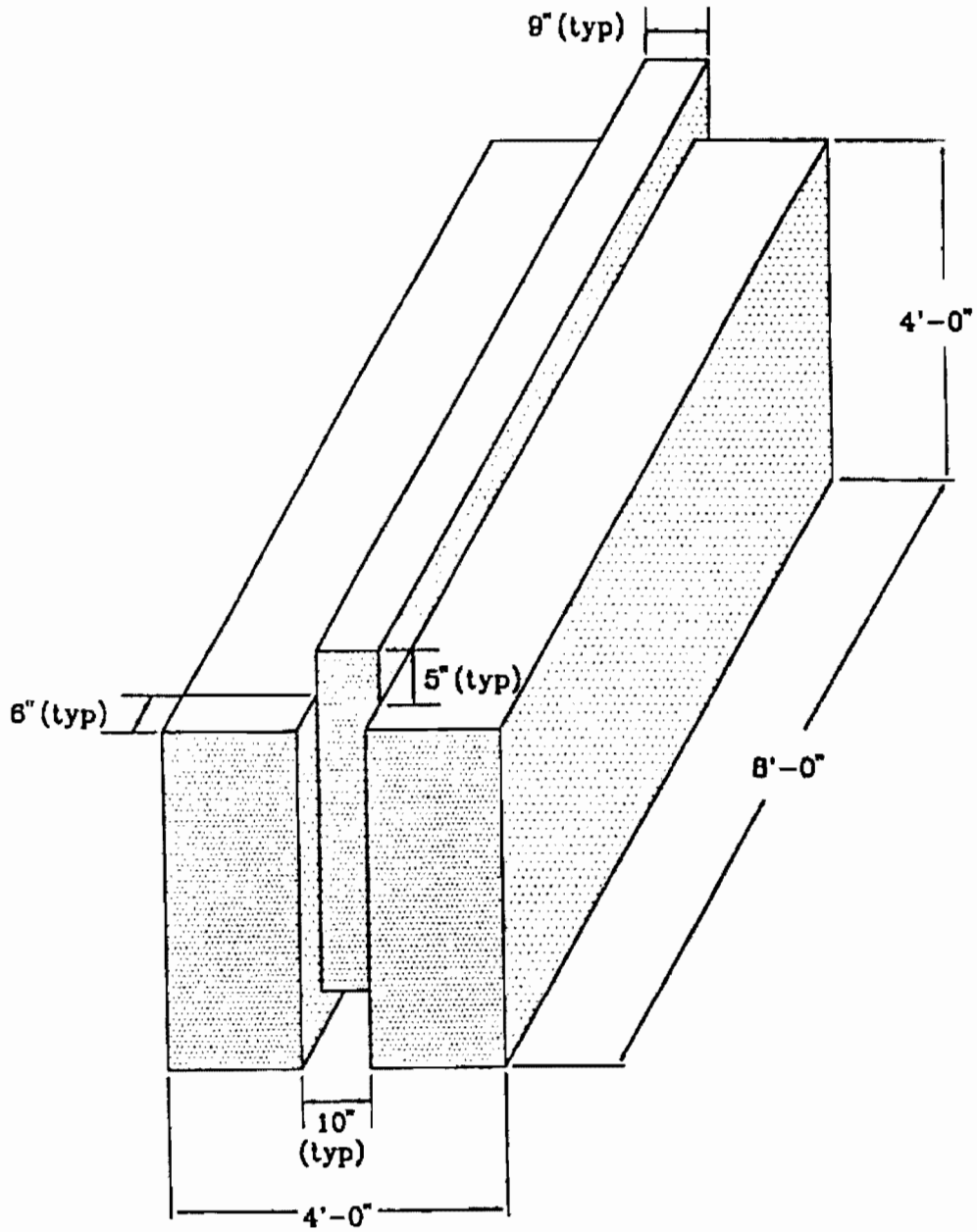

Figure 2.9: Oblique View of Eco-Bloc Unit (11)

2.3.3.1 Design of the Unit

Three alternative designs of Eco-Bloc™ are presented based on the use of 3000 psi concrete. Alternatives one and two meet the minimum reinforcing requirements of the American Concrete Institute (ACI), ACI 318-89 (revised 1992) specifications. These alternatives are suitable for structural applications and the engineering properties of a single unit (for either alternative one or two) are given in Table 2.2. Figure 2.10 shows the first alternative, which consists primarily of welded wire fabric reinforcing. The second alternative, shown in Figure 2.11, consists of number three steel reinforcing bars. The third alternative is a plain concrete unit with corner reinforcing only and it is shown in Figure 2.12. It does not meet ACI code requirements and is not applicable for structural applications requiring code conformance. The engineering properties of this alternative are given Table 2.3. This alternative may be subject to shrinkage and/or thermal induced cracking.

Table 2.2: Engineering Properties of Single Unit-Steel Reinforced (11)

Property	Units	Value
Weight	lbs	13,900
Allowable Surcharge Capacity	kips	200
Allowable Punching Shear on Side Wall		
6"X6" area	lbs	9,000
9"X9" area	lbs	11,900
12"X12" area	lbs	14,900
Allowable Lateral Load Capacity of Tongue	kips/ft	19.0
Allowable Bending Capacity of Single Unit with Simply Supported Ends (uniform load)	kips/ft	18.8

Table 2.3: Engineering Properties of Single Unit-Plain Concrete (11)

Property	Units	Value
Weight	lbs	13,900
Allowable Surcharge Capacity	kips	200
Allowable Punching Shear on Side Wall		
6"X6" area	lbs	9,000
9"X9" area	lbs	11,900
12"X12" area	lbs	14,900
Allowable Lateral Load Capacity of Tongue	kips/ft	19.0
Allowable Bending Capacity of Single Unit with Simply Supported Ends (uniform load)	kips/ft	6.0

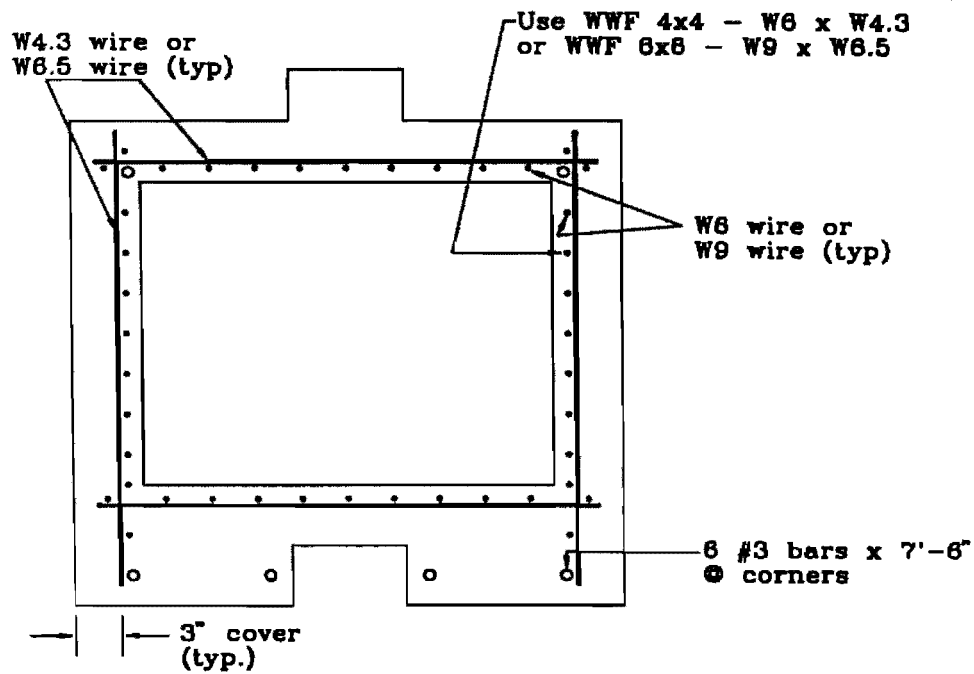

Figure 2.10: Eco-Bloc Reinforcing Using Welded Wire Fabric (11)

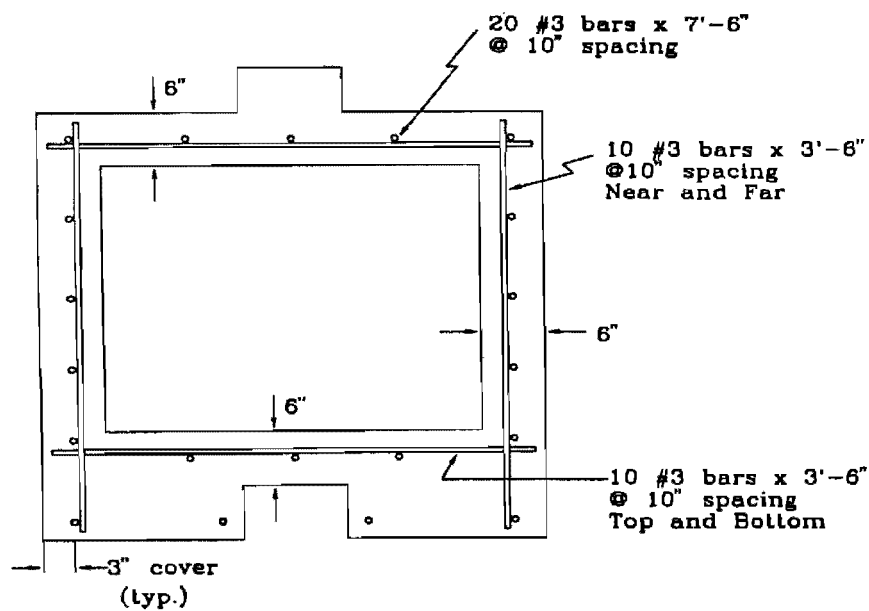

Figure 2.11: Eco-Bloc Reinforcing Using No. 3 Rebar (11)

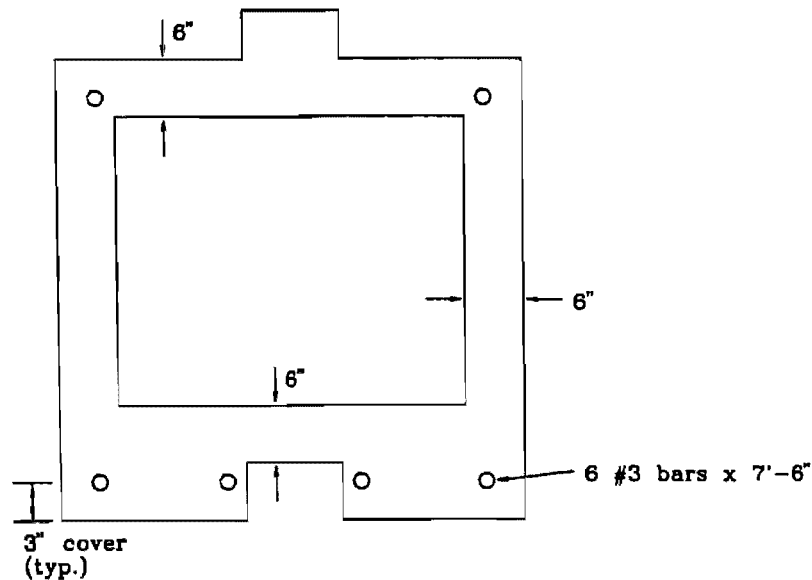

Figure 2.12: Eco-Bloc Using Plain Concrete (11)

2.3.4 Different Applications of Eco-Bloc

Eco-Blocs can be used in different Civil Engineering applications. Some of the typical usage of Eco-Blocs are in erosion control, wetland reclamation, traffic diversion, building dikes or dams, sound barriers, warehouses, retaining walls, equipment barns, parking lot levelers, retaining walls for bulk material, river wing dams, border walls, prison walls and energy efficient homes. Figure 2.13 shows a retaining wall and Figure 2.14 shows a river wing dam built using Eco-Bloc™ units.

2.3.5 Features and Benefits of Using Eco-Bloc™ in Retaining Walls

Following are some of the features of Eco-Bloc™ units, which have beneficial effects on constructing retaining walls.

- a. Standard block has a 32 square foot base, which allows it to act as a foundation unit eliminating the need for extra foundations.
- b. Eco-Bloc's interlocking system makes the installation simple and cost-effective. This interlocking also resists lateral movement.
- c. Each block contains about 1 ton of waste material, which recycles waste from environment. This also reduces concrete cost by approximately half, which significantly reduces the cost and weight of the block.
- d. The blocks can be manufactured at/near construction site, which reduces overhead, and transportation cost.
- e. The blocks can easily be reinstalled at another job site, as these are portable.
- f. The simplicity in manufacturing and installation minimizes the need for technically skilled manpower.
- g. This program can establish a community resource conservation program.



Figure 2.13: Walls Using Eco-Bloc Units (10)



Figure 2.14: River Wing Dam Built Using Eco-Blocs (10)

2.3.6 Economics of Construction by Eco-Bloc™

Each Eco-Bloc™ unit contains about 1 ton of waste material, which reduces concrete cost by approximately half, which significantly reduces the cost and weight of the block. Standard block has a 32 square foot base (4'×8'), which allows it to act as a foundation unit eliminating the need for extra foundations. The blocks can be manufactured at/near construction site, which

reduces overhead, and transportation cost. The production price of each Eco-Bloc unit is currently approximately US \$ 175/unit (10).

2.4 En-Core Tire Bales in the Construction of Retaining Walls

2.4.1 En-Core Baler (12)

The En-Core baler is manufactured by ENCORE SYSTEMS, inc., headquartered in Cohasset, Minnesota. The En-Core baler is a vertical down stroke portable baler which compresses approximately 100 whole passenger and light truck tires into a block measuring 30 " × 50 " × 60 ". The baler has a chamber of about 5'×4'×2.5' which needs to be filled three to five times before enough tires are compressed to complete the bale. The baling process is shown in Figures 2.15-2.17. It takes about 15 minutes to produce a bale depending upon the speed of the hydraulic system and the type of supportive equipment used. Average production is 400 tires per hour. The weight of the completed block is approximately one ton. This is a volume reduction of 5 to 1. The bales are secured with 5 strands of 9-gauge wire. The wires are 12 feet long, 2300-pound tensile strength, made of carbon steel, galvanized or stainless steel with a "Square Loc" connecting knot.

In some cases, the bales are painted or coated with soil, shot-crete, plastic, foam, or rubber compounds. Coating the bales improves the aesthetics and creates a barrier to extend the integrity of the wire almost indefinitely.

The baler and two men are capable of making from four to six bales an hour on a steady basis. The completed bales are ejected automatically. The completed bales can be handled with a forklift, front-end loader, logger's clam or grappler. According to the manufacturers, because of the uniformity of the bales, they can be easily stacked.



Figure 2.15: Tires Being Loaded in the Baler (12)



Figure 2.16: Tires being Compressed in the Baler (12)

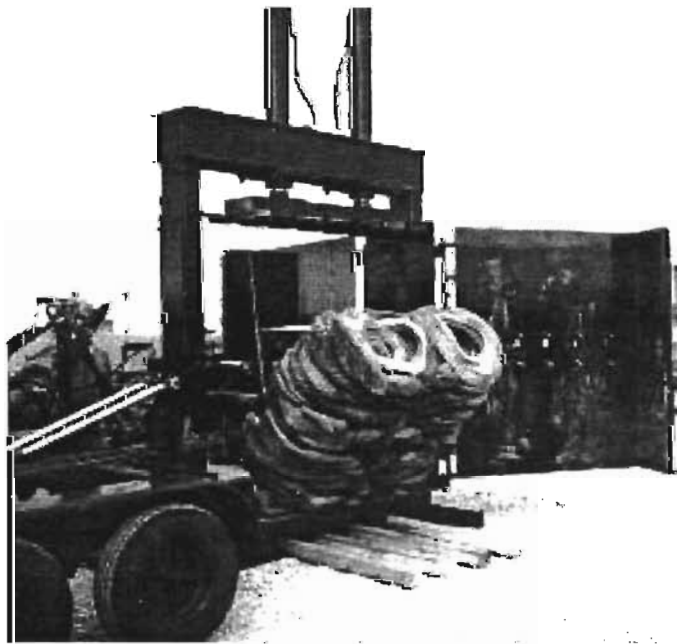

Figure 2.17: Finished Bale Being Ejected From the Baler (12)

2.4.2 Summary of Test Results on En-Core Tire Bale (13)

Stork Twin City Testing Corporation in St. Paul, Minnesota performed a creep test and a load deflection test on a tire bale submitted by the Encore Systems of Cohasset, Minnesota. In the creep test, the average ultimate deflection after 72 hours was 8.06 inches under a load of 88,000 lb. In the load deflection test, the average ultimate deflection was 11.45 inches under the maximum load of 338,850 lbs.

2.4.3 Benefits of Using Baled Whole Tires (12)

ENCORE SYSTEMS, inc. claims that the baler is relatively inexpensive, has virtually no down time, and has very low maintenance costs.

Tires in baled form do not hold water; therefore, pose no threat to public health due to mosquitoes. Because of the density of the bale, the decreased surface area, and lack of air, the fire hazard is greatly reduced. The volume reduction of 5 to 1 makes the storage and transportation of tires more convenient. The uniformity of the bales makes them a feasible product to be used in Civil Engineering applications.

The comprehensive advantage to this method of scrap tire processing is the potential use as an end product. Increasing disposal costs and state laws make the option of baling whole tires an attractive and cost-effective alternative.

2.4.4 Costs of Baler. (12)

The operating and maintenance costs, as given by the ENCORE SYSTEMS, inc. are given below.

1. Hydraulic Maintenance Costs

Based on 48 H.P. Kubota diesel engine baling 1,000 bales @ 4 bales/hour

Assuming \$10/hour labor costs, 1 hour labor @ \$10.00/hour = \$ 10.00

Filters/Parts — \$ 27.85

Hydraulic Maintenance Costs To Bale 1,000 Bales = \$ 37.65

2. Engine Maintenance (Kubota) Costs

1 hour labor @ \$10.00 per hour = \$10.00

parts (filters, oil change) = \$15.00

Engine Maintenance Costs = \$ 35.00

3. Fuel Consumption Costs

48 H.P. Kubota diesel engine - 1.25 gallons/hour.

1,000 bales @ 4 bales per hour = 250 hours

@ \$1.25/gallon = \$ 250.00

4. Labor Costs

3 men @ \$10.00/man per hour baling 1,000 bales in 250 hours = \$ 7,500.00

5. Wire Costs

5 galvanized wires per bale

1,000 bales = 5,000 wires @ \$.45/wire — \$ 2,250.00

6. Total Cost to Bale 1000 Bales/100,000 Tires
= \$10,072.65/ \$.10 per tire.

2.4.5 Different Applications of Baled Tires

Many successful projects have already been completed using the bales. Some of these projects include impact barriers, erosion control, land reclamation, equine training arenas, fences, and dam construction. Tire bales were used in erosion control projects like that in Carlsbad, New Mexico; Manitou Springs, Colorado and Cohasset, Minnesota. Tire bales have been used as Subgrade Lightweight Fill for Road Construction in Chautauqua County, New York and also in Pueblo, Colorado. Figure 2.18 shows the bales being used as Subgrade Lightweight Fill for Road construction. Entrance walls and Equipment buildings have been built utilizing the bales in Pueblo, Colorado. Over 5,000 bales have been used to elevate 4 acres of soil for using as a parking lot. Over 50,000 bales have been used to build a dam in Mountain Home, Arkansas. They were used as fill material on both the upper and lower sides of the dam.

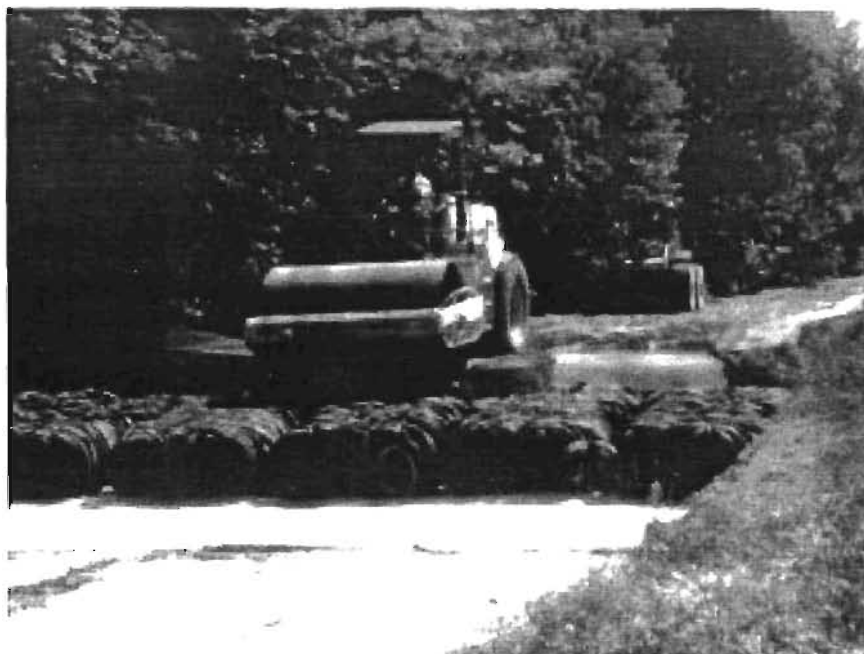

Figure 2.18: Tire Bales as Subgrade Lightweight Fill for Road Construction (12)

2.4.5.1 A Brief Description of Carlsbad, NM Project (12)

This project began in September of 1997, and used approximately 700,000 recycled scrap tires in the form of one-ton bales to stabilize 4,400 feet of the East bank of the Pecos River in Lake Carlsbad.

Figure 2.19 shows the extent of erosion near the Carlsbad Country Club. The erosion was being caused by wave action of pleasure watercraft. The river was drained to allow for construction of the erosion control project.

The first step was to dig a three to four foot deep trench along the river's edge. This was lined with a concrete foundation, and set with steel reinforcing bars. Then, one-ton bales produced by Encore's Baler were set on top of the concrete and secured in place. Figure 2.20

shows the bales on top of concrete foundation. The next step involved encapsulating the tire bales in concrete. The encapsulation process is shown in Figure 2.21. The encasement in concrete enabled the tire bales to serve as a foundation for a concrete block wall, and prepared them for the application of a layer of facing stone, which was laminated to the front of the bales. A block retaining wall was then constructed on top of the bales and backfill was applied behind the wall. Figure 2.22 shows the block retaining wall on top of the bales.



Figure 2.19: Erosion in Lake Carlsbad (12)



Figure 2.20: Bales on top of Concrete Foundation (12)



Figure 2.21: Encapsulation of Tire Bales in Concrete (12)



Figure 2.22: Block Retaining Wall on Top of Bales (12)

2.5 Facing Materials for Tire Retaining Walls

Once a tire retaining wall has been designed and built it is necessary to make it aesthetically pleasing for the general public. In order, to do this the tires need to be covered in some manner. Several possibilities were examined. Initial research was done using the internet. After locating the products, manufactures were contacted via e-mail and/or the telephone in order to obtain more information. Several manufacturers sent the requested information as well as brochures and samples of their products. The information that was gathered is displayed in Tables 2.4, 2.5, and 2.6. Detailed information about costs was not available because the exact nature of the project is not known. The general classification of these methods are stucco, shotcrete, concrete blocks with a rock facing, vegetative covering, geofabric, and paneling. Stucco and shotcrete use portland cement as one of their basic components. They both allow an extensive variety in form and texture. Both are low maintenance, have good strength, and have a long life.

Table 2.4: Tire Retaining Wall Facing Materials/Products: Most Promising Candidates

Product	Manufacturer	Material/Product Description	Properties
Shotcrete	Nationwide Gunite Corp. 25133 Avenue Tibbits, Suite J Valencia, CA 92865 888-7-GUNITE	a mixture of portland cement, sand, and coarse aggregate	high bond strength low permeability flexural/compressive strengths freeze/thaw resistance
Stucco	Merlex Stucco Inc. 2911 Orange-Olive Rd. Orange, CA 92865 714-637-1700	a mixture of portland cement, sand and hydrated lime	strength & hardness low maintenance good insulating properties long life excellent fire resistance
Vegetative Covering	any local plant nursery	plants are placed into the center of the tires	easy of installation high maintenance
Geofabric	Tenax 4800 East Monument Street Baltimore, Maryland 21205 410-522-7000	textiles consisting of synthetic fibers that are woven or matted together	varies with fibers used and how they are woven or matted
Concrete Blocks with Rock Facing		concrete block wall that is covered with a topper cement that rocks are then embedded in the cement	high strength resistance to weathering

Table 2.5: Various Types of Panels Used as Wall Facing

Product	Manufacturer	Material/Product Description	Properties
Exterior Slate Panels	Structural Slate Company P.O. Box 187 Pen Argyl, Pennsylvania 18072 800-67-SLATE	1"-2" thick, slate panels	resistance to acids resistance to water penetration durable
Cladding Panels	James River Steel, Inc P.O. Box 11498 Richmond, VA 23230 800-825-0717	various steel paneling available	versatile weather-tight seals corrosion resistant
Ceramic Steel	Alliance 4888 South Old Peachtree Rd. Norcross, GA 30071 800-631-4514	ceramic that has been fused to steel	strong as steel resistance of glass does not oxidize resistance to breaking
Gold Board	Alta Goldboard 4990 - 92nd Avenue, Suite 1033 Edmonton, AB T6B 2V4 403-440-3320	straw-based panel	strength of particleboard dimensional stability light weight
Simpson Guardian Siding	Marketer International Group P.O. Box 1721 Clackamas, Oregon 97015 503-650-4788	overlaid, plywood siding	weather-tested durability easy to work with economical

Table 2.6: More Panels Used as Wall Facings

Product	Manufacturer	Material/Product Description	Properties
Panels	Bellcomb 70 North 22nd Avenue Minneapolis, MN 55411 612-521-2425	panels with a honeycomb core and various skins or frames	lightweight fire resistance structural strength varied skin surfaces high compression strength dimensional stability water resistance sound control
Stone Panels	Stone Panels, Inc. 1725 Sandy Lake Rd. Carrollton, Tx 75006 972-446-1776	honeycomb-reinforced panels with a stone exterior	high impact resistance high flexural strength high wind load capacity impervious to water penetration acid freeze thaw resistant
Precast Concrete Panels	Smith-Midland P.O. Box 300 Midland, Va 22728 540-439-3266	precast concrete panels	same as those for cast-in-place concrete
Nida Core	Nida-Core 3240 SW 42nd Avenue Palm City, FL 34900 561-287-6464	extruded polypropylene honeycomb used as a lightweight core in sandwich composite panels	light weight sound barrier ease of use material integrity excellent bond

Concrete blocks with a rock facing, vegetative covering, geofabric, and shotcrete are methods that are currently in use. Various kinds of paneling were looked at and appear in Table 2.5. Paneling was determined to be cost prohibitive, and therefore, will not be discussed here in great detail. The methods (see Table 2.4) that appear to be the most promising are shotcrete, stucco, vegetative covering, geofabric, and the concrete blocks with a rock facing.

2.5.1. Shotcrete

Shotcrete is defined as any concrete or mortar that is sprayed into place by pneumatic projection. In many cases, shotcrete differs from conventional concrete only because of its method of mixing, conveying, and placing (compaction). Shotcrete when properly applied is a structurally sound and durable construction material. It exhibits excellent bond characteristics to existing concrete, rock, steel, and many other materials. Shotcrete can have high strength, low absorption, good resistance to weathering, and resistance to some forms of chemical attack. The physical properties of shotcrete are comparable or superior to those of conventional concrete or mortar having the same composition. Shotcrete is best used in applications where formwork is cost prohibitive or impractical. It is also used where forms can be reduced or eliminated, access to the work area is difficult, thin layers or variable thickness are required, or normal casting techniques cannot be used. Since its introduction, shotcrete has been used for the repair of existing structures. Through the years, the uses of shotcrete have grown to include: new construction, repair, slope stabilization, underground support, rock support, and cathodic protection of reinforced concrete. Figure 2.23 shows a retaining wall made of tires using a shotcrete facing.

2.5.2. Stucco

Stucco is a portland cement, sand, and hydrated lime mixture. Stucco is available in both interior and exterior grade. Stucco as an exterior wall finish offers several benefits. These include strength and hardness, long life, low maintenance, fire

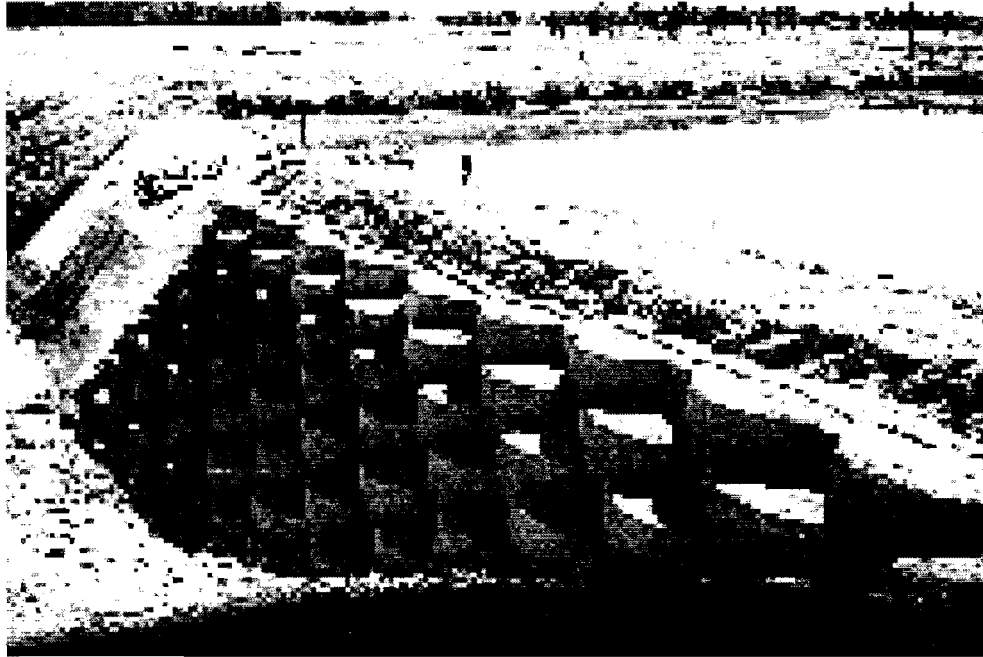

Figure 2.23: Shotcrete over Tires, Salt Ash, Newcastle (8)

resistance, and good insulating properties. Stucco is considered low maintenance because there is no periodic painting required. Stucco is typically trowelled into place over masonry walls or wood paneling. Stuccos of today offer a wide range of long-lasting colors and lifetime water repellency through the use color pigments and silicone additives. A variety of textures is also available from stucco, ranging from smooth to very coarse. Stucco is typically used as the exterior finish of a house. It has also been used in the construction of swimming pools and Figure 2.24 shows a short concrete block retaining wall that has been coated in stucco. Interior applications include detailed moldings and the coating of areas subject to repeated wetting.

2.5.3. Vegetative Covering

Another option that is being used right now is vegetative covering. Plants are placed into the tire centers and allowed to grow until they cascade over the tires. Thus, the tires are hid behind a screen of vegetative growth. Possible problems arising from the use of this method are the high maintenance costs associated with keeping the plant growth alive and looking good, and the replacement of dead plants with living ones.



Figure 2.24 Stucco Over Concrete Blocks (15)

Figure 2.25 shows a retaining wall using this option. The tires were filled with compacted dirt, which made it possible to place the plants in the tire centers.

2.5.4. Geofabric

Figure 2.26 shows a tire retaining wall that has been covered by a geofabric in order to disguise the tires. Geofabrics are also referred to as geotextiles. Geotextiles are textile in the traditional sense, but consist of synthetic fibers rather than natural ones such as cotton, wool, or silk. These synthetic fibers are turned into flexible, porous fabrics by standard weaving machinery or are matted together in a random or non-woven manner. The properties of a geotextile vary with the type of synthetic fiber used and how it is woven or matted together. A geotextile can be found for most applications depending on the design criteria. Geotextiles are used within foundation, soil, rock, earth and any other geotechnical engineering-related material as an integral part of a human-made project, structure, or system.

2.5.5. Concrete Blocks

A concrete block wall with a rock facing can also be used to disguise the tires. The concrete used in the blocks is a typical cement, sand, and coarse aggregate mix. The mix used in the blocks is altered to fit the strength and durability characteristics desired. Block sizes can vary with the application and desired outcome. The concrete blocks are held together using rebar and mortar. Once the blocks are in place, they are covered with topper cement into which stones are imbedded. Topper cement is concrete with sand but no coarse aggregate. The stones can vary in size and color to accommodate the desired finished look of the facing. This method provides a strong, weather resistant covering. Some problems will arise with taller retaining walls. The blocks will need to be anchored to the wall in order to prevent tipping over.



2.25 Vegetative Covering, Sound Barrier. Redhead, New Castle (8)



Figure 2.26: Geofabric over Tires Salt Ash, Newcastle (8)

2.5.6. Combinations

A possible combination would be to combine the concrete blocks with the vegetative covering. This method would work best where tiered walls could be used. The concrete blocks would cover the front facing of the tires, while the vegetation would be placed in the center of the tires. This possibility would have the same problems as both the concrete block and vegetative ones.

CHAPTER III

STABILITY ANALYSIS AND DESIGN OF RETAINING WALL

3.1 Overview

From the research project's comprehensive literature review, two types of retaining wall were chosen for further review and analysis. One was a Mechanically Stabilized Earth retaining wall utilizing both scrap tires and Eco-Bloc units and the other was Gravity retaining wall using both scrap tires and Encore Tire Bales. In the mechanically stabilized earth (MSE) retaining wall, the earth mass is reinforced with a series of strips, which are attached to a facing material. The facing resists the lateral thrust induced by the active earth pressure, through the anchorage provided by the strips. The strips derive their tensile capacity from the friction developed between the strips and the earth. Figure 3.1 shows a typical MSE wall construction using whole scrap tires and Figure 3.2 shows Eco-Bloc units. Gravity retaining walls depend solely on their weight for stability. In the case of gravity walls made from scrap tires (Figure 3.3), whole tires are filled and stacked creating the block. Different shapes of gravity retaining wall made of Encore Tire Bales are shown in Figure 3.4. This chapter presents detailed stability analysis for each type of wall.

3.2 Mechanically Stabilized Earth Tire Retaining Walls

Scrap Tires and Eco-Bloc units were used as the main element to analyze and design mechanically stabilized earth retaining walls. The walls were designed considering all possible modes of failure.

3.2.1 Modes of Failure

MSE walls shall be designed for external stability of the wall system as well as internal stability of the reinforced soil mass behind the facing. Both the external and internal stability failure problems were addressed in the design procedure.

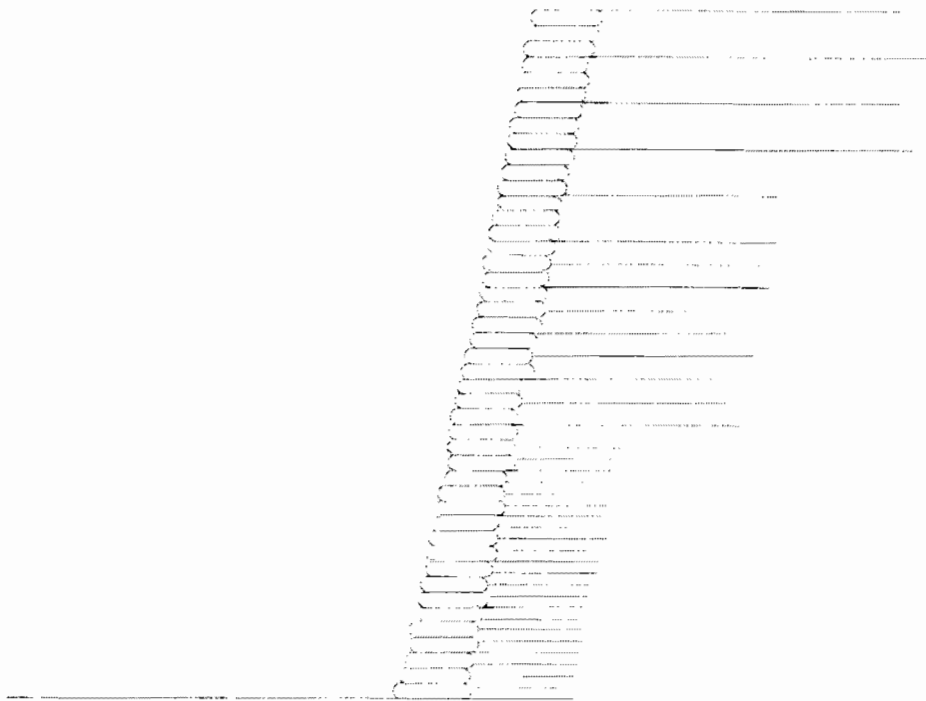

Figure 3.1: Mechanically Stabilized Earth Wall employing scrap tires

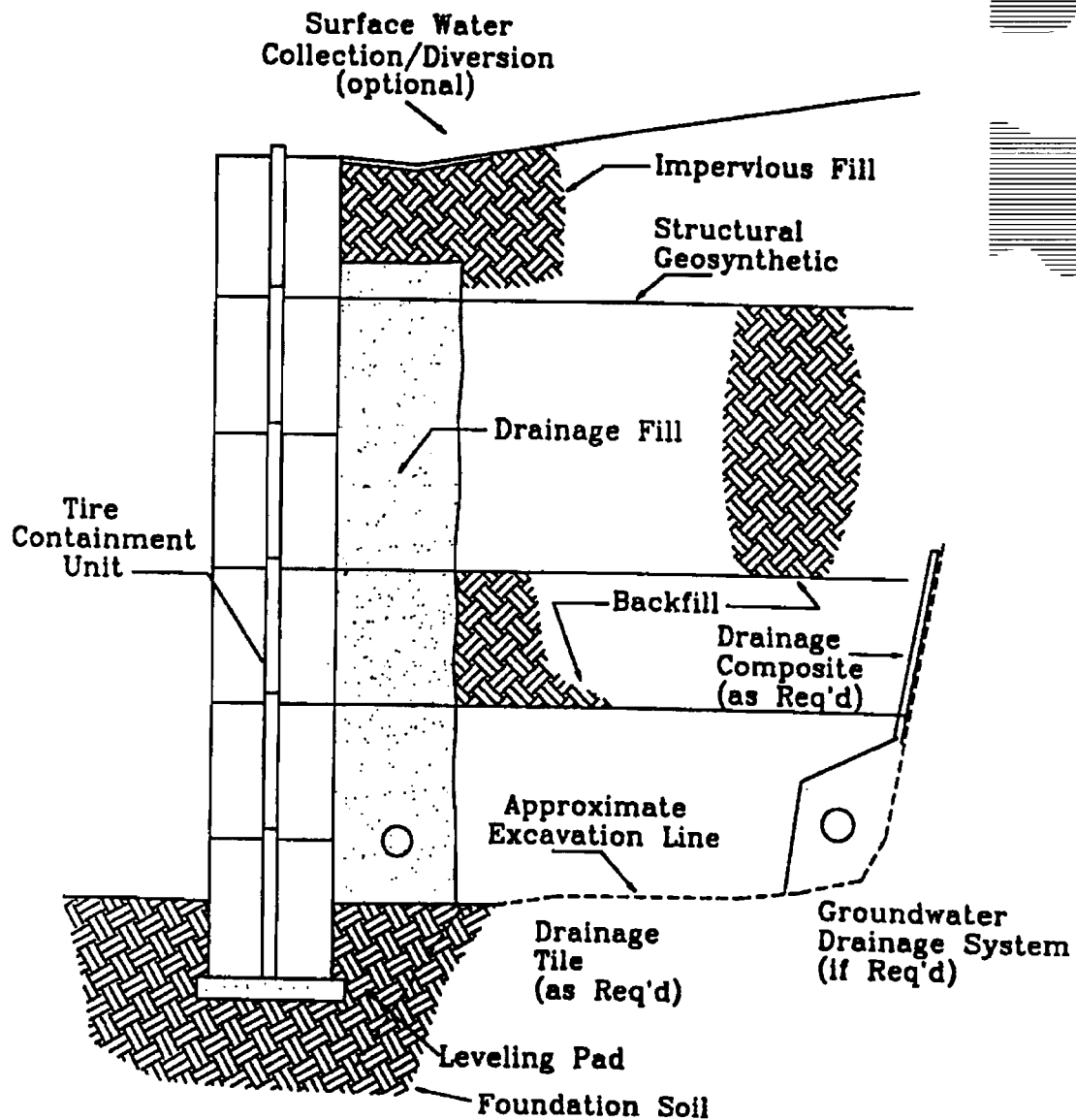

Figure 3.2: Typical MSE Wall Construction using Eco-Bloc Units (11)

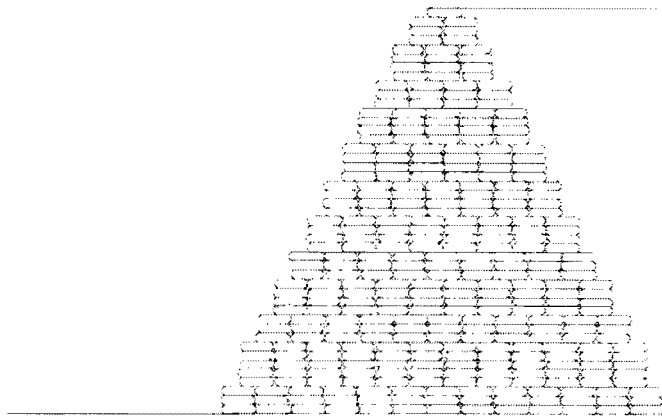
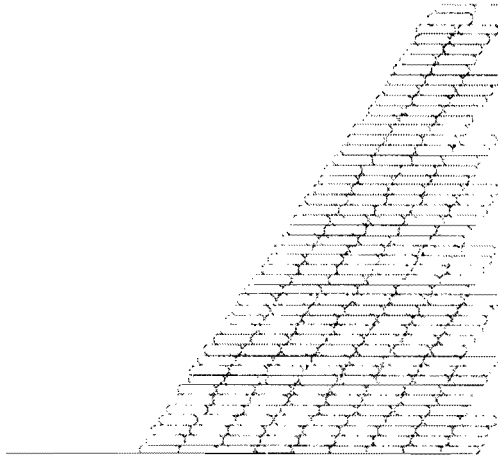
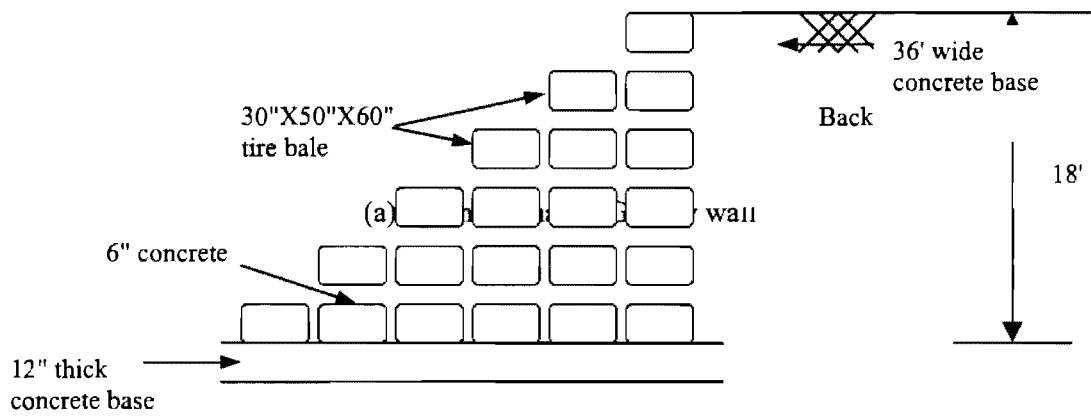
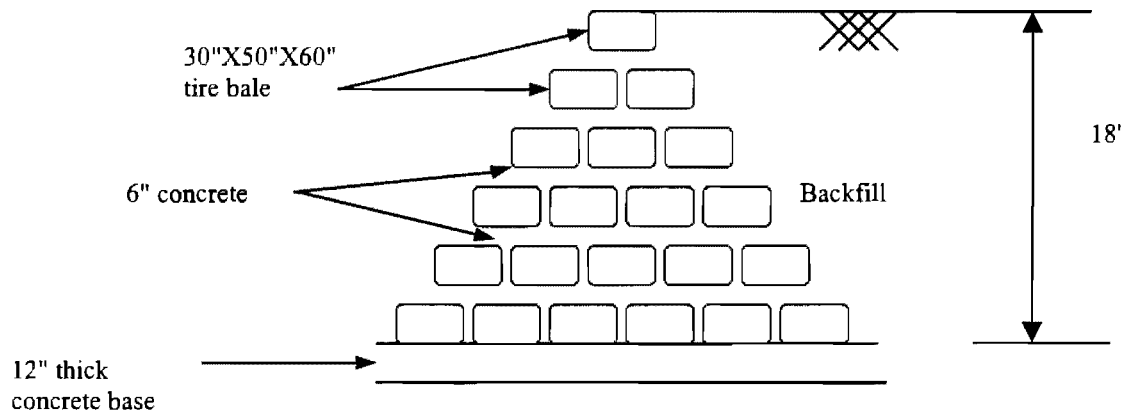
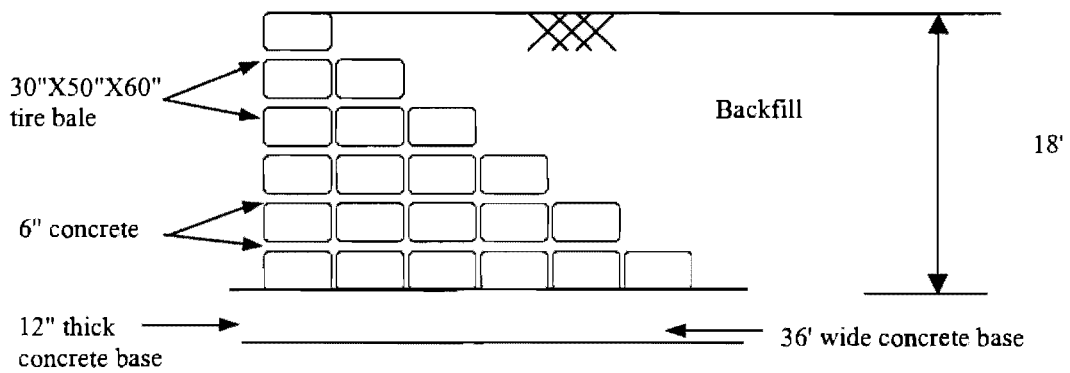

Figure 3.3: Gravity Walls made of Scrap Tires



(b) Front-Stepped Gravity wall



(c) Rear-Stepped Gravity wall

Figure 3.4: Gravity Walls of Different Shape utilizing Tire Bales

3.2.1.1 External Stability

Stability computations shall be made by assuming the reinforced soil mass and facing to be a rigid body. The external stability of an earth wall depends on the ability of the reinforced soil mass to withstand external loads, including the horizontal earth pressure from the soil being retained behind the wall and loads applied to the top of the wall, without failure by one of the failure mechanisms: sliding of the reinforced volume along the base of the wall or along any plane above the base, overturning about the toe of the wall, bearing capacity failure or loss of serviceability because of excessive settlement of the foundation soil and rotational or block sliding failure of the soil behind and beneath and earth wall (i.e., an overall slope failure).

Sliding Failure: It represents the ability of the reinforced structure to overcome the horizontal force of the soil immediately behind it. The sliding failure mechanism is shown in Figure 3.5 (a). The factor of safety of an earth wall against sliding is typically taken as 1.5.

Overturning Failure: this model the ability of the structure to overcome the overturning moment created by the soil pressures acting behind it. Figure 3.5 (b) shows the overturning failure mechanism. Design engineers have generally accepted that reinforced soil walls should have a factor of safety of at least 2.0 with respect to overturning.

Bearing Capacity Failure: The bearing capacity of the foundation soil must be checked to ensure that the vertical load exerted from the weight of the wall and surcharge is not excessive. Figure 3.5 © is an example of bearing capacity failure. The generally accepted minimum factor of safety against this type of failure for reinforced soil walls is 2.0.

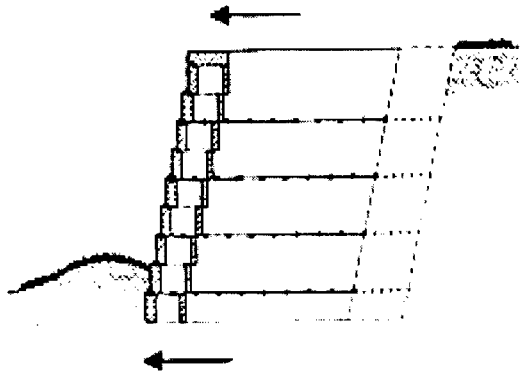

(a) Sliding

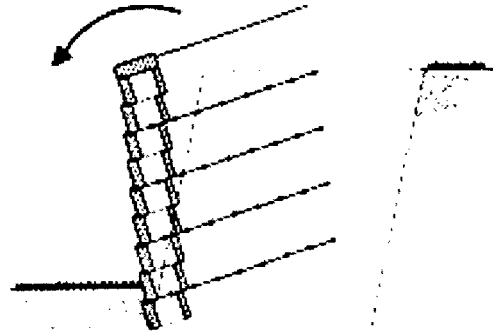

(b) Overturning

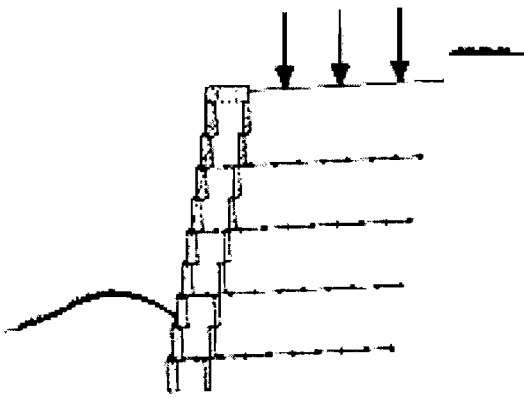

(c) Bearing Capacity

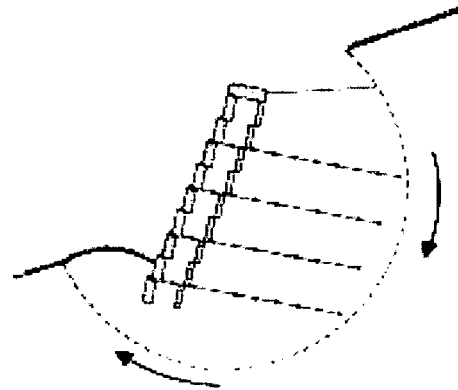

(d) Global Failure

Figure 3.5: External Stability Failure Mechanisms of MSE Retaining Walls
Source: Allan Block Design Manual

3.2.1.2 Internal Stability

Internal stability requires that the reinforced soil structure be coherent and self-supporting under the action of its own weight and any externally applied forces. Reinforcement loads calculated for internal stability design are dependent on the soil reinforcement extensibility and material type. In general, inextensible reinforcements consist of metallic strips, bar mats, or welded wire mats, whereas extensible reinforcements consist of geotextiles or geogrids. Internal stability failure modes include soil reinforcement rupture and soil reinforcement pullout. For a reinforced soil structure to be internally stable, the reinforcements must be able to carry the tensile stresses transferred to them by the soil without rupture. In addition, there must be sufficient bond between the reinforcements and the soil in the resisting zone that reinforcements do not pull out under the load that they are required to carry. The basis for the internal design is to evaluate the required spacing and lengths of reinforcements so as to satisfy the rupture and pullout criteria. Internal stability is determined by equating the tensile load applied to the reinforcement to the allowable tension for reinforcement, the allowable tension being governed by reinforcement rupture and pullout. Figure 3.6 shows the failure mechanism of a mechanically stabilized retaining wall due to lack of internal stability.

The load in the reinforcement is determined at two critical locations, i.e., at the zone of maximum stress and at the connection with the wall face, to assess the internal stability of the wall system. Potential for reinforcement rupture and pullout are evaluated at the zone of maximum stress. The zone of maximum stress is assumed to be located at the boundary between the active zone and resistant zone. Potential for reinforcement rupture and pullout are also evaluated at the connection of the reinforcement to the wall facing.

A very important additional internal design consideration concerns loss of reinforcement durability over time. Reinforcement deterioration can result from corrosion, creep, and chemical and biological attack of the different reinforcement materials. Current practices in design to prevent failure as a result of reinforcement deterioration include use of additional reinforcement cross section to allow for corrosion loss, epoxy coating of metallic reinforcements, protection of geotextiles from exposure to ultraviolet light, and design at reduced stress levels to minimize creep in plastic grids and geotextiles.

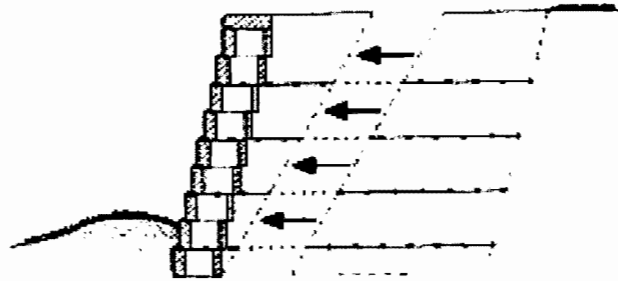

(a) Breakage

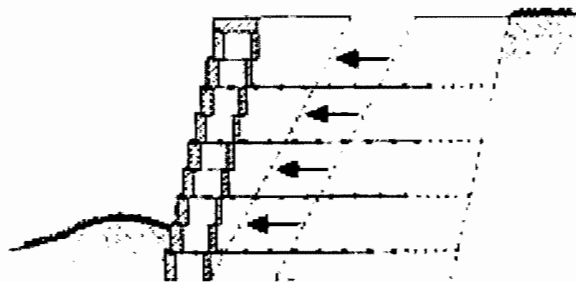

(b) Pullout

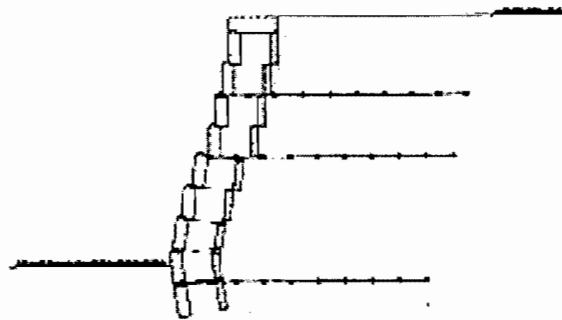

(c) Bulging

Figure 3.6: Internal Stability Failure Mechanisms of MSE Retaining Walls
Source: Allan Block Design Manual

3.2.2 Stability Analysis and Design of Retaining Wall

The present concept of systematic analysis and design of reinforced earth structures was developed by a French Engineer, H. Vidal (1966). The mechanically stabilized earth (MSE) retaining wall uses the principle of introducing reinforcing into a granular backfill via mechanical means such as metal strips and rods, geotextile strips and sheets, or wire grids.

The three basic components of MSE retaining walls are:

1. Earth fill – usually granular material with less than 15% passing #200 sieve.
2. Reinforcement- strips or rods of metal, strips or sheets of geotextiles or wire gridding fastened to the facing unit and extending into the backfill some distance.
3. Facing unit- not necessary but used to maintain appearance and to avoid soil erosion between reinforcements. It may be curved or flat metal plates or precast concrete strips or plates. In our case, Eco-Bloc units serve as the facing unit.

MSE walls derive their lateral resistance through the dead weight of the reinforced soil mass behind the facing. The current design procedures for reinforced earth retaining structures consider the internal and external stability analyses separately. MSE walls shall be dimensioned to ensure that the minimum factors of safety required for both internal and external stability are satisfied. Different wall dimensions were analyzed for different loading conditions, soil backfill properties and different types of reinforcement. Both inextensible (metallic strips) and extensible (geotextile and geogrid) types of reinforcement were considered in the design procedure. Diversified soil backfill properties (friction angle varying from 25° to 36°) were considered. Different site settings (horizontal backslope and sloping backslope) were analyzed in the design. Dissimilar loading conditions (surcharge and non-surcharge) were analyzed. General Design Procedure for MSE Walls: - The following general procedure was followed for the design of MSE walls.

1. Establish wall profile and design loadings.
Establish wall profile from the grading plan of the wall site and verify the following design assumptions:
 - a) The wall face is vertical or nearly vertical
 - b) The backfill is granular and free draining
 - c) The wall is constructed over a firm foundation or stabilized, improved soils
 - d) The live loads are vertical.

If any of the design assumptions are not satisfied, the design method must be modified.

2. Determine the properties of backfill soil, foundation soil and retained soil.

Well-graded and free-draining granular material should be used as backfill of mechanically stabilized earth reinforced walls. The friction angle, ϕ , of the soil can be estimated conservatively by a soil engineer or determined by performing appropriate direct shear or triaxial tests. Diversified friction angle ranging from 25° to 35° was considered in the analysis for MSE walls made of Eco-Blocs. The friction angles analyzed for MSE walls made of scrap tires were

32°, 34° and 36°. The unit weight, γ , can be determined in a moisture density test. Generally, the unit weight at 95% Standard Proctor relative compaction is specified. A unit weight of 110-115 lb/ft³ was assumed in the analysis of the wall. Obtain the shear strength and allowable bearing capacity of the foundation soil. Determine soil-tie friction angle, ϕ_u .

3. Establish design factors of safety.

Suggested values of safety factors used in the stability analysis are as follows:

I. External Stability

- a. Sliding, $F_s \geq 1.5$,
- b. Overturning, $F_o \geq 2.0$,
- c. Bearing Capacity, $F_b \geq 2.0$.

II. Internal Stability

- a. Breakage Strength, $F_B \geq 2.5$,
- b. Pullout resistance, $F_P \geq 2.5$.

4. Determine preliminary wall dimensions.

Determine the height of the wall, H. The range of height selected for scrap tire retaining walls were 4 to 30 feet with wall being designed at 2-foot increments. The 2-foot increment was decided on based on the typical passenger vehicle tire being 8-inches wide with three making up a 2-foot block. Therefore, the design heights are 4, 6, 8, 10, 12, 14, 16, 18, 20, 22, 24, 26, 28, and 30 feet. Heights extending from 4' to 16' were analyzed for the mechanically stabilized earth retaining wall made of Eco-Bloc units. The heights were incremented at an interval of 4', since the depth of the Eco-Bloc units are 4'. The heights for gravity retaining walls utilizing En-Core Tire Bales ranged from 3' to 18'. Their height interval was 3' as the depth of the En-Core Bale is 3'. An embedment depth, D is usually required for reinforced earth structures to avoid bearing failure of the foundation soil. Embedment is also required because of risk of local failure in the vicinity of the spacing, depth of frost and risk of scour or erosion-induced local damage. In any case, an embedment depth of 0.1 H is usually used, H being the height of the wall.

5. Select reinforcement type and strength.

Both inextensible (metallic strips) and extensible (geotextile and geogrid) types of reinforcement were considered in the design procedure.

Metallic strips of 1.6 by 0.2 inch with an ultimate tensile strength of 36-kip/sq. in. were considered in the analysis. Both the geotextile and geogrid were assumed to have allowable tensile capacity of 100 lb/inch (17.5 kN/m). This is a conservative value since the wide width tensile strength of geotextile varies from 9-180 kN/m (25).

6. Determine actions of lateral earth pressure due to overburden pressure and live loads.

Active Earth Pressure Coefficient,

$$K_a = \frac{\sin^2(\theta + \phi)}{\sin^2 \theta \sin(\theta - \delta) \left[1 + \frac{\sin(\phi + \delta) \sin(\phi - \beta)}{\sin(\phi - \delta) \sin(\theta + \beta)} \right]^2} \dots\dots\dots(3.1)$$

Where:

- θ = back face of the retaining wall, ($\theta=0$ for vertical back face of the wall)
- ϕ = angle of internal friction of backfill soil,
- δ = friction angle between back face of the wall and soil backfill,
- β = slope of backfill.

The parameters of the above equation are shown in Figure 3.7.

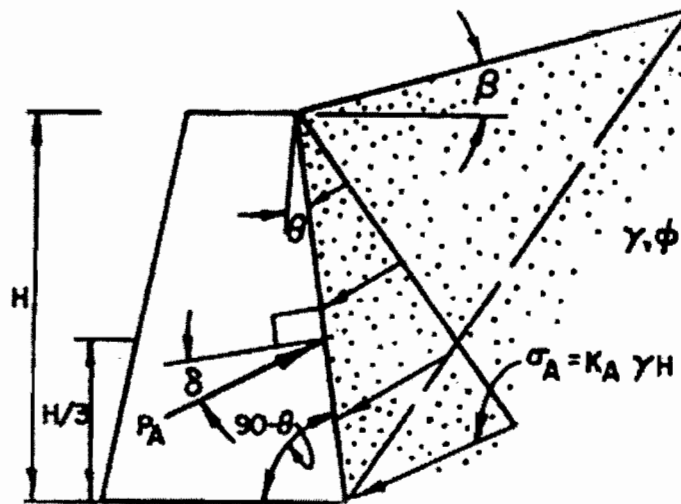

Figure 3.7: Coulomb's Active Earth Pressure (22)

Both sloping and non-sloping conditions were analyzed in the design procedure. A typical, modest slope of 15° was analyzed to represent a sloping back slope. For a non-sloping backfill, the above formula simplifies to the simplest form of Rankine equation,

$$K_a = \tan^2(45 - \phi/2) \dots\dots\dots(3.2)$$

7. Calculate horizontal tensile stress at each reinforcement level:

Maximum vertical pressure on nth layer, $\sigma_v = \gamma_z + q$,
 Maximum horizontal pressure on nth layer, $\sigma_h = K_a (\sigma_v)$.

Where:

γ = unit weight of backfill,
 z = depth of reinforcement,
 K_a = active earth pressure coefficient,
 q = surcharge.

A surcharge value of 500 lb/ft² spanning over 25 ft was analyzed in the design for MSE walls made of Eco-Bloc units. For scrap tires, the surcharge value was assumed at 250 psf.

Maximum tensile stress at nth layer,

$T = (\text{active earth pressure at depth } z) \times (\text{area of the wall to be supported by the tie})$

$$= (\sigma_h) \times (s_v \times s_h) \dots \dots \dots (3.3)$$

Where:

σ_h = horizontal pressure on reinforcement,
 s_v = vertical spacing between reinforcements,
 s_h = horizontal spacing between reinforcements.

Figure 3.8 shows the schematic tensile force lines for both inextensible and extensible reinforcements.

For metallic strips, values of horizontal and vertical spacing were assumed.

For geotextile or geogrid, the vertical spacing of fabric layers (s_v) is calculated from:

$$S_v = \frac{T_{all}}{\sigma_h F_B} \dots \dots \dots (3.4)$$

Where:

T_{all} = allowable fabric long-term tensile force per unit width,
 σ_h = total lateral earth pressure for the layer,
 F_B = factor of safety against rupture.

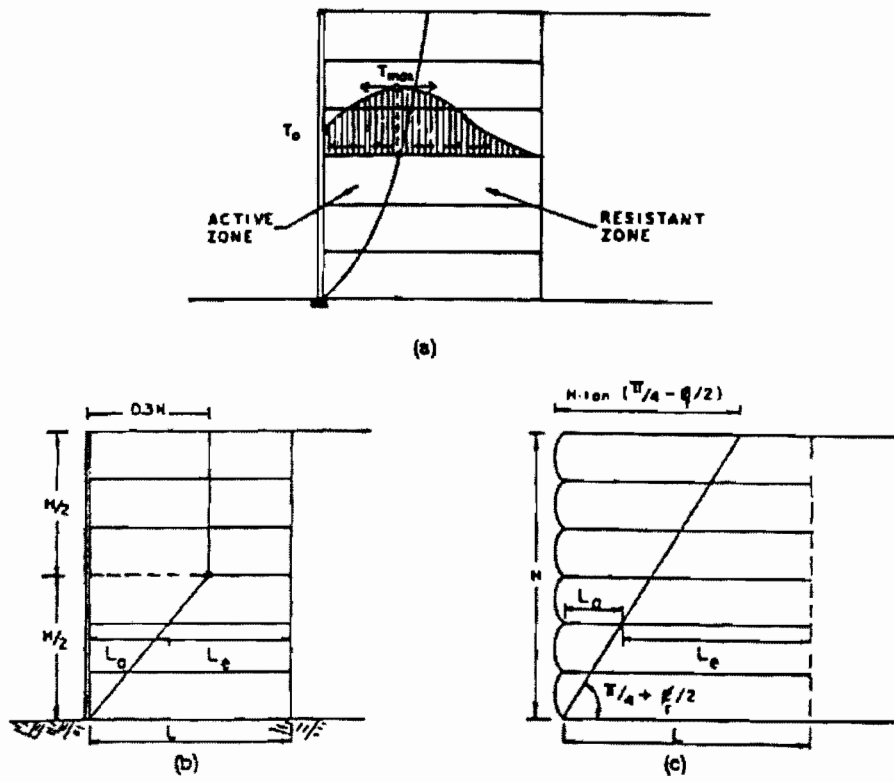

Figure 3.8: Tensile Forces in the Reinforcements and Schematic Maximum Tensile Force Lines: (b) inextensible reinforcements, (c) extensible reinforcements

Source: James K. Mitchell and Barry R. Christopher, North American Practice in Reinforced Soil Systems, DESIGN AND PERFORMANCE OF EARTH RETAINING STRUCTURES, Geotechnical Special Publication No. 25, 1990.

The design specifications assume that the wall facing combined with reinforced backfill acts as a coherent unit to form a gravity retaining structure. The effect of relatively large vertical spacing of reinforcement on this assumption is not well known, and a vertical spacing greater than 0.8 m (31 inches) shall not be used without full scale wall data (e.g., reinforcement loads and strains, and overall deflections) which supports the acceptability of larger vertical spacing.

8. Check internal stability.

Reinforcement loads calculated for internal stability design are dependent on the soil reinforcement extensibility and material type. Maximum reinforcement load is obtained by multiplying a lateral earth pressure coefficient by the vertical pressure at the reinforcement, and applying the resulting lateral pressure to the tributary area for the reinforcement. The applied load to the reinforcement shall be calculated on a load per unit of wall width basis.

Check against reinforcement rupture for each layer n.

For metallic strips,

$$T < T_{all} = \frac{T_s \times w \times t}{F_B} \dots \dots \dots (3.5)$$

Where:

- T= developed tensile force in the reinforcement,
- T_{all}= allowable tensile stress of the reinforcing material,
- T_s= ultimate tensile stress of the reinforcing material,
- F_B = Factor of Safety against rupture,
- w = width of each tie,
- t = thickness of each tie.

For geotextiles or geogrids,

$$T < T_{all} = \frac{T_{ult}}{RF} \dots \dots \dots (3.6)$$

Where:

- RF= RF_{ID}×RF_{CR}×RF_D,
- T_{all} = long-term tensile strength required to prevent rupture,
- T_{ult} = ultimate tensile strength of the reinforcement,
- RF = combined reduction factor to account for potential long-term degradation due to installation damage, creep, and chemical aging,
- RF_{ID} = strength reduction factor to account for installation damage to the reinforcement,
- RF_{CR} = strength reduction factor to prevent long term creep rupture of the reinforcement,
- RF_D = strength reduction factor to prevent rupture of the reinforcement due to chemical and biological degradation.

9. Determine length of reinforcements:

$$\text{Total length of ties at any depth is } L = L_r + L_e \dots\dots\dots(3.7)$$

Where:

- L_r = length within the Rankine /Coulomb failure zone,
- L_e = Effective length of reinforcements.

The effective length of ties along which the frictional resistance is developed may be conservatively taken as the length that extends beyond the limits of the Rankine active failure zone.

At any depth z ,

$$L_r = \frac{h - z}{\tan(45 + \phi / 2)} \dots\dots\dots(3.8)$$

Where:

- h = height of wall,
- z = depth of reinforcement,
- ϕ = angle of internal friction of backfill soil.

Check against reinforcement pullout for each layer n .

Pullout occurs when the reinforcement is pulled out of the soil by the internal forces of soil causing the wall to experience bulging or even worse, falling apart. Adequate length of reinforcement prevents pullout. The reinforcement pullout resistance shall be checked at each level against pullout failure for internal stability. A factor of safety of about 2.5-3 is generally recommended for ties at all levels.

For a given factor of safety against reinforcement pullout, F_p

$$L_e = \frac{F_p \sigma_a s_v s_h}{2w \sigma_v \tan k\theta} \dots\dots\dots(3.9)$$

For sheets of geotextile, the values of w and s_h are meaningless. So, the equation becomes

$$L_e = \frac{F_p \sigma_a s_v}{2\sigma_v \tan k\theta} \dots\dots\dots(3.10)$$

Where:

- F_p = factor of safety against pullout,
- σ_a = lateral earth pressure at depth z ,
- σ_v = vertical earth pressure at a depth z ,
- s_v = vertical spacing of reinforcement,
- s_h = horizontal spacing of reinforcement,
- w = width of reinforcing ties,
- $k\phi$ = soil-tie friction angle (can be conservatively assumed to be 2/3 of internal friction angle of backfill, ϕ).

Find fabric wrapped embedment length for geotextile.

The length of fabric-wrapped embedment, L_o is calculated by dividing the lateral pressure-induced tension in the fabric by the friction mobilized between the soil and fabric over its overlap length. The required fabric overlap length is calculated from:

So, a minimum fabric embedment length of 3 ft should be used.

$$L_o = \frac{s_v \sigma_h FS}{4\sigma_v \tan(k\phi)} \geq 3 \text{ ft} \dots\dots\dots(3.11)$$

10. Check the external stability of the wall:

Check for overturning, sliding and bearing capacity failure needs to be done to ensure the external stability of the MSE wall.

(a) Check for overturning.

The factor of safety against overturning is defined as the ratio of the sum of stabilizing moment to the sum of overturning moment. The moments are calculated by taking moments about the toe of the footing.

F_o = Resisting Moment, M_R /Overturning Moment, M_O

$$M_R = (\text{Weight of soil, } W_s) \times (\text{distance of } W_s \text{ from front face of wall}) + (\text{Weight of block, } W_b) \times (\text{distance of } W_b \text{ from front face of wall}) + (\text{Weight of surcharge } q, W_q) \times (\text{distance of } W_q \text{ from front face of wall}) \dots\dots\dots(3.12)$$

$$M_O = \text{Total soil thrust, } P_a \times \text{distance of } P_a \text{ from base of wall} = 1/2 K_a \gamma H^2 \times H/3 + K_a q H \times H/2 \dots\dots\dots(3.13)$$

(b) Check for Sliding.

The factor of safety against sliding is defined as the ratio of the sum of horizontal resistance forces to the sum of horizontal disturbing forces.

$$F_s = \text{Horizontal resisting forces/ Horizontal driving forces} = (W_s + W_b + W_q)(\tan k\phi) / (1/2 K_a \gamma H^2 + K_a q H) \dots\dots\dots(3.14)$$

Where:

$$k\phi = \text{friction angle at geotextile-soil interface} = 2/3 \phi.$$

(c) Check for Bearing Capacity Failure.

Since allowable bearing capacity depends on site conditions and these walls may be used in a variety of conditions, a conservative approach was followed to check against bearing capacity failure. Allowable bearing capacity of 3000 lb/ft² was assumed in the design. Actual bearing pressure coming to the base was then calculated. The maximum pressure usually occurs

beneath the toe. This value must not exceed the allowable bearing capacity of the soil, otherwise settlement or vertical yielding may occur. Factor of safety against bearing capacity failure was then determined by dividing allowable bearing capacity (3000 lb/ft²) by the actual bearing pressure. In some cases, the reinforcement length had to be increased to satisfy this criterion. Equations 3.15 and 3.16 were used to obtain the actual bearing pressure coming to the foundation soil.

$$\text{Eccentricity, } e = \frac{0.5\gamma H^2 Ka(H/3) + qH Ka(H/2)}{W_s + W_b + qL} \dots\dots\dots(3.15)$$

$$\text{Bearing pressure, } \sigma = \frac{W_s + W_b + qL}{L - 2e} \dots\dots\dots(3.16)$$

3.3 Gravity Retaining Walls

Scrap Tires and En-Core tire bales, produced by Encore Systems, inc., were used as the building block for analyzing construction of gravity walls. Different wall dimensions were analyzed for different loading conditions and different soil backfill properties.

3.3.1 Modes of Failure

A gravity wall is typically internally stable. The failure mechanisms of a gravity wall are the same as those for the external stability of a mechanically stabilized earth retaining wall. For the purpose of checking external stability, a gravity wall is treated as a rigid monolith (i.e., no internal yielding or distortion).

3.3.2 Stability Analysis

The same principles applied to ensure the external stability of the MSE wall was applied to check the external stability of the gravity wall.

CHAPTER IV

CONCLUSIONS AND RECOMMENDATIONS

4.1 Overview

As there are more and more vehicles on the roads, the disposal of used tires increases. The already intense problem of what to do with the tires will only magnify. The used tires will end up more and more in illegal dumps. Illegal dumps pose major environmental and safety problems. They do not take care to stave off the problems with stockpiling tires, such as combustibility and possible toxins in the leachate. They also can be breeding ground for insects such as mosquitoes, which can be hazardous to the safety of people in the area. Mechanically stabilized earth and gravity walls have the possibility of being a good way to reuse large quantities of tires. They appear to be economically competitive and no harder to construct than conventional walls. Though more information is needed before they can be used on a regular basis. Some of the needed information will be gathered if a test wall is built. The rest can be gathered from environmental impact analyses and economic analyses.

4.2 Conclusions

4.2.1 Costs

The exact cost of either the mechanically stabilized earth or gravity wall is unknown since a wall has not been built according to the specifications laid out in Catalog of Design Details and Charts. The assumption can easily be made that the walls will be cheaper. This assumption has some validity since the cost of the primary construction material, tires, is only the cost to transport them. Some data is available on the cost of used tire mechanically stabilized earth walls based on previous case studies where similar structures were built using scrap tire. The wall built by the United States Forestry Service cost about \$13 per square foot of face. While the slope stabilization project built by the Santa Barbara Public Works Department was about \$27 per square foot. This project included both the construction of walls and the roadway. Based on these figures, the range of \$13 to \$30 per square foot appears to be reasonable. The actual cost of the wall is dependent on the type of fill and the kind of facing material chosen as well as labor costs. The tire rubber is a dense, durable and elastic material that does not undergo natural decomposition easily and therefore, have a very long life. It has been estimated that walls made of tires can last over 100 years. This will help reduce the total life cycle cost. Increasing disposal costs and state laws make the option of baling whole tires an attractive and cost-effective alternative. The global advantage to this method of scrap tire processing is the potential use of an unproductive material that had to be disposed of to a landfill with some disposal costs. The project's literature search reveals that the tire bales are a potential product for Civil Engineering applications like erosion control, wetland reclamation, construction of dam, retaining wall, etc. Each tire bale contains about 1 ton of waste material, which recycles waste from environment. This also reduces concrete cost by approximately half, which significantly reduces the cost and weight of the block. Mechanically stabilized earth and gravity walls utilizing tire bales appear to be two practical solutions to the disposal problem of scrap tires. Both of them appear to be cost-effective as well as environment-friendly.

4.2.2 Constructability

Both the mechanically stabilized earth and gravity walls appear to be constructible without the need for special equipment or skilled labor. In the construction aspect, these walls are a mix of cast-in-place concrete walls and block walls. The tires are laid out like blocks and then filled with a flowable fill like pouring concrete into forms. In this case though no forms are needed since the tire cavities supply their own formwork. The only aspect that might become labor intensive is the connecting of the tires to each other. The Eco-Bloc units should have to have some connection mechanisms to connect the reinforcements because connection mechanisms at every half-foot of the block was assumed in the design.

4.2.3 High Volume Applications

While the mechanically stabilized earth walls use a minimum of tires the gravity walls use a large quantity. Assuming a tire size of 2.5 feet in outside diameter and 8 inches wide enables the estimation of the quantities of tires involved. A mechanically stabilized earth wall utilizing scrap tires uses at least 3 tires per every 2 feet of height and 2.5 feet of length of the wall. This means that a 30-foot high wall uses 45 tires per every 2.5 feet of wall. Again, a mechanically stabilized earth wall consuming tire bales utilizes 120 tires for every 4 feet height and 8 feet length. A 4-foot gravity wall employing scrap tires uses at least 4 tires per 2.5 feet while a 30-foot wall uses about 350 tires per 2.5 feet. Gravity retaining walls made up of tire bales employ 100 scrap tires for each 3 feet high and 5 feet long wall. As shown these walls can greatly reduce the amount of tire being discarded instead of being reused. Every tire that does not get disposed in a stockpile, landfill, or illegal dump makes a difference. Since tires will not undergo natural decomposition then it is necessary to use them or to place them into an already taxed system. These walls provide a way to use large quantities of tires instead of placing them in landfills. This is one of the significant benefits of using tires in this manner. By placing the tires in a gravity or mechanically stabilized wall they will not land in a dump where many problems can arise like fires.

4.3 Recommendations

4.3.1 Test Wall

No test wall could be built because of lack of funds in the project. A test wall needs to be built to complement the stability analysis. Both the mechanically stabilized earth retaining wall and the gravity retaining wall need to be test-built before their implementation. A full-scale test should enable the constructability review to be done. Constructability review addresses different issues such as material availability, speed of construction and other aspects of construction. Construction details would be fully understood and tested. A constructibility review could be performed and necessary modifications can be made in the wall design so that the wall construction process will be more streamlined. Load testing could be completed and hence the designs validated. Future problems could be observed and corrected before they became problems in a setting where people could be hurt. Labor aspect could be determined such as how labor intensive is the construction of the wall.

4.3.2 Economic Analysis

An economic analysis is necessary to see if the cost of the wall construction versus benefits to be gained through saving of landfill space. The analysis should take into account the long life of the structure and well as the benefits of the high volume use of the tires. Also the cost of labor would be determined and factored in. All these factors would help to determine if the mechanically stabilized earth and gravity walls are a practical application of tires.

4.3.3 Environmental Impact

In several instances there have been problems noted with the presence of whole scrap tires. In open stockpiles, the presence of oxygen and the steel wires can cause the tires to ignite and burn for a long time. In marine setting tires have been known to have leachate problems. The leachate from around the tires has been found to be high in elements that are toxic to the indigenous life forms such as fish. However, no significant threat to the environment is anticipated as a result of tire retaining walls that are built according to the proposed designs. Tires, once filled with suitable filler, will not have sufficient supply of oxygen to sustain a fire. Similarly, since the tires are used as whole units and not in shredded form their ability release harmful constituents to percolating water is minimal. Nevertheless it should be noted that this research has not examined the potential impact on the environment from the construction of tire retaining walls.

BIBLIOGRAPHY

1. Rubber Manufacturers Association homepage, <http://www.rma.org>.
2. Scrap Tire Management Council, *Technical Briefing Sheets*, Washington, DC, March 1997.
3. Texas Natural Resources Conservation Commission, "Waste Tire recycling Program," <http://www.tnrcc.state.tx.us/waste/msw/tires/index.htm>, May 1999.
4. Sonti, Kiranmayi, *Use of Scrap Tires in Civil Engineering Application*, Master's Report, Texas Tech University, August 1999.
5. "Proximity and Ultimate Analysis of TDF", Waste Recovery, Inc., Hazen Labs, 1997.
6. "Efficiency Results of Multi-Fuel Firing", ABB Combustion Engineering Services, Inc., Waste Recovery Inc., 1993.
7. Keller, G., "Retaining Forest roads," *Civil Engineering*, Vol. 60, Number 12, Dec 1990.
8. Sulcal Constructions Pty Ltd., "ECOFLEX Home," <http://www.sulcal.com>, June 1999.
9. Sulcal Constructions Pty Ltd., *Sulcal Constructions Pty Ltd.*, June 1999.
10. Ecological Building Systems homepage, <http://www.comwerx.net/biz/ecobloc>.
11. Avent, R, Richard and Alawaddy, Mohamed, ANALYSIS AND DESIGN OF CONCRETE TIRE CONTAINMENT UNIT, April 1995.
12. Encore Systems, Inc. homepage, <http://www.tirebaler.com>.
13. Stork Twin City Testing Corporation, Project: MNDOT Test of Tire Bale, Project No:03066, Date: March 24, 2000.
14. McGolpin, S. and William Tracy, "Old Tires Get New Life," *Roads and Bridges*, Vol.35, No.3, March 1997.
15. Clegg Plastering Inc., "Stucco Blockwalls and Decorative Concrete Coatings," <http://www.stucco.org>, April, 2000.
16. 1997 Interim Revisions to the Standard Specifications for Highway Bridges, 16th Edition, 1996, American Association of State Highway and Transportation Officials.
17. Reinforcement of Earth Slopes and Embankments, National Cooperative highway Research Program Report 290, Transportation Research Board, Washington, D.C., June 1987.

18. Design and Performance of Earth Retaining Structures, Geotechnical Special Publication No. 25, American Society of Civil Engineers, 1990.
19. Design Manual, Allan Block Retaining Wall Systems, <http://www.allanblock.com>.
20. Das, Braja M, Principles of Foundation Engineering, 3rd Edition, PWS Publishing Company, Boston, Massachusetts, 1995.
21. Bowles, Joseph E., Foundation Analysis and Design, 4th Edition, McGraw-Hill, Inc., 1988.
22. Day, Robert W., Geotechnical and Foundation Engineering, McGraw-Hill, Inc., 1999.
23. Liu, Cheng and Evett, Jack B., Soils and Foundations, 4th Edition, Prentice Hall, Englewood Cliffs, New Jersey, 1990.
24. Jones, Colin J FP, Earth Reinforcement and Soil Structures, Butterworths, 1985.
25. Koerner, R.B., Design with Geosynthetics, 2nd Edition, Prentice Hall, Englewood Cliffs, New Jersey, 1990.
26. Whitlow, R., Basic Soil Mechanics, 3rd Edition, Longman Scientific and Technical, 1995.
27. Cernica, John N., Geotechnical Engineering: Foundation Design, John Wiley & Sons, Inc., 1995.
28. Brown, Robert Wade, Practical Foundation engineering handbook, McGraw-Hill, 1996.

APPENDIX
METHODS INVESTIGATED FOR FACINGS



STRUCTURAL SHOTCRETE AND GUNITE SPECIALISTS - GENERAL ENGINEERING CONTRACTORS

25133 Avenue Tibbits, Suite J
Valencia, CA 91355
Phone: (888) 7-GUNITE / (661) 257-4228
Fax: (661) 257-4887

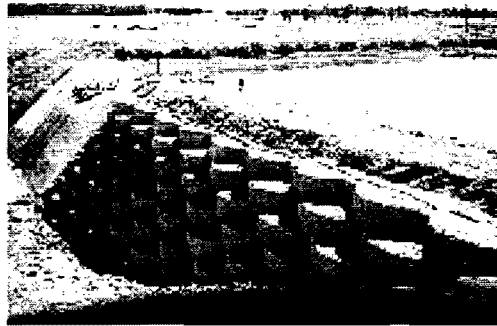

Material and Construction:

Shotcrete is defined as any concrete or mortar that is sprayed into place by pneumatic projection. It is a mixture of portland cement, sand, coarse aggregate, and water. In many cases, shotcrete only differs from conventional concrete only because of its method of mixing, conveying, and placing (compaction).

Typical Applications:

Shotcrete is best used in applications where form work is cost prohibitive or impractical. It is also used where forms can be reduced or eliminated, access to the work area is difficult, thin layers or variable thicknesses are required, or normal casting techniques cannot be used. Shotcrete has been used for the repair of existing structures, new construction, slope stabilization, underground support, rock support, and cathodic protection of reinforced concrete.

Advantages:

- Structurally sound
- Durable
- Excellent bond characteristics
- High strength
- Low absorption
- Good resistance to weathering
- Resistance to some forms of chemical attacks
- Can be textured and colored to obtain a desired appearance

Disadvantages:

- Difficult to obtain an adequate air-entrainment in order to ensure resistance to freeze/thaw
- Requires specialized equipment and trained crews for placement

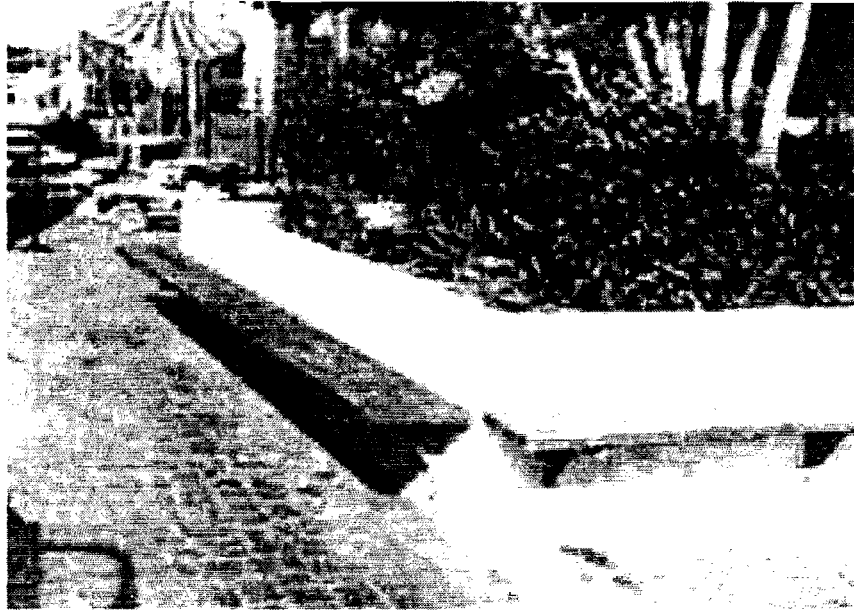

2911 Orange-Olive Rd.
Orange, CA 92865
Phone: (714) 637-1700
Fax: (714) 637-4865

Material and Construction:

Stucco is a mixture of portland cement, sand, and hydrated lime. It is available in both an interior and exterior grade. Stucco, through the use of additives is available in a wide variety of colors.

Typical Applications:

Stucco is typically used as the exterior finish of a house. It has also been used in the construction of swimming pools and as a coating for concrete block retaining walls. Interior applications include detailed moldings and the coating of areas subject to repeated wettings.

Advantages:

- High strength
- Hardness
- Long life
- Low maintenance
- Fire resistance
- Good insulating properties
- Wide variety of colors
- Wide variety of textures

Disadvantages:

- Exhibits water stains and may darken with time
- Should be applied by trained plastering craftsmen
- Cannot be applied in cold-damp weather

Vegetative Covering

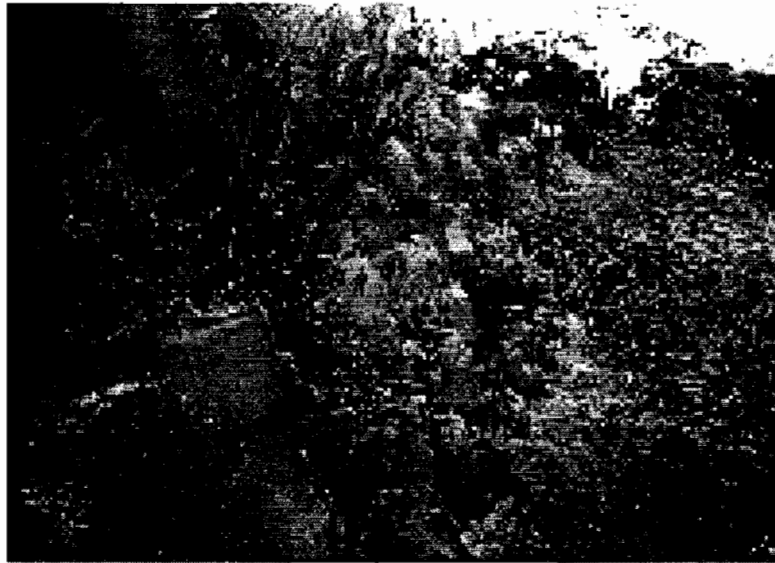

Material and Construction:

In vegetative covering, plants are used to cover the tires. The plants are placed in the tire centers and allowed to grow until they cascade over the tires. All ivy type plants are ideal for this purpose.

Typical Applications:

Vegetative covering has been used before in retaining walls made of tires, geotextiles, and concrete blocks. Vegetative covering has also been used for slope stabilization.

Advantages:

- Natural look
- Inexpensive
- Wide variety of plant available

Disadvantages:

- High maintenance associated with keeping the plants alive
- The upper layers of tires must be filled with loosely compacted dirt or the surface needs to be covered with a layer of dirt

Geofabric



Material and Construction:

Geofabrics, or geotextiles, are textiles in the traditional sense, but consist of synthetic fibers rather than natural ones such as cotton, wool, or silk. These synthetic fibers are turned into flexible, porous fabrics by standard weaving machinery or are matted together in a random or non-woven manner. The properties of a geotextile varies with the type of synthetic fiber used and how it is woven or matted together.

Typical Applications:

A geotextile can be found for most applications depending on geotechnical engineering – related material as an integral part of a human-made project, structure, or system. Geotextiles typically perform one of the following functions: separation, reinforcement, filtration, drainage, and containment.

Advantages:

- Low maintenance
- Wide variety available
- Easy to install

Disadvantages:

- Possible high cost
- Aesthetics, the appearance can be sloppy, the material can sag
- Reacts to temperature changes, it contracts and expands

Concrete Blocks with Rock Facing

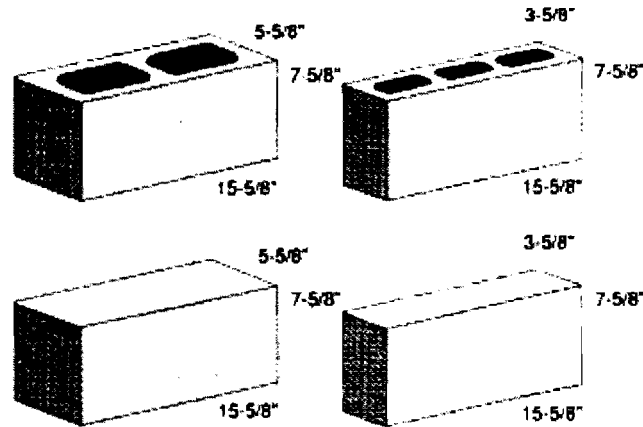

Material and Construction:

A concrete block wall with a rock facing has been used to hide the tires. The concrete blocks are made from a typical concrete mixture: portland cement, sand, coarse aggregate, and water. The mix used in the blocks is altered to fit the strength and durability characteristics desired. Block sizes can vary with the application and desired outcome (some possible sizes are shown above). The blocks are held together using rebar and mortar. Once the blocks are in place, they are covered with a topper cement into which the stones are imbedded. Topper cement is concrete with sand but no coarse aggregate. The stones can vary in size and color to accommodate the desired finished look of the facing.

Typical Applications:

A concrete block wall with a rock facing was used in the New Mexico project to cover the tire bales. This method can be used for shorter retaining walls and for the exterior of a building.

Advantages:

- Strong
- Weather resistant
- Variety of finished looks available
- Low to no maintenance

Disadvantages:

- Installation is labor intensive
- Taller walls will require the blocks to be anchored to the tires

The Structural Slate Company

222 East Main Street
P.O. Box 187
Pen Argyl, Pennsylvania 18072-01
Phone: (800) 67-SLATE
Fax: (618) 863-7016

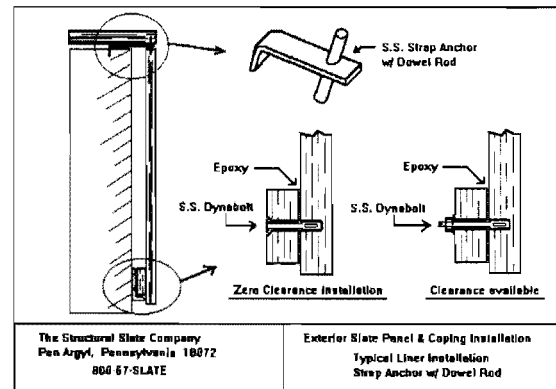
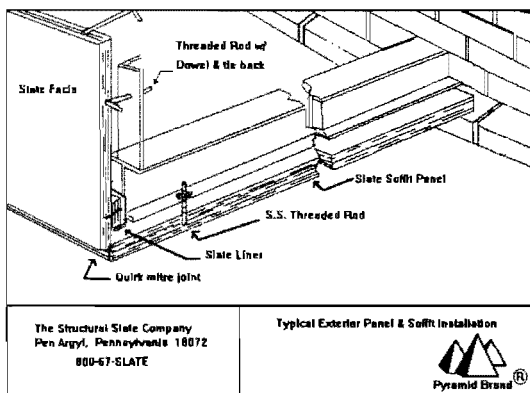

Material and Construction:

Clear Grade slate is used for exterior panels. This slate conforms to ASTM C-629 for Class 1 slate. Clear slate is free of ribbons and most markings. It is blue-gray to blue-black in color and if sealed or otherwise treated it is approximately "jet black." Exterior panels are typically supplied in 1", 1 1/4", 1 1/2", and 2" thicknesses.

Typical Applications:

Standard products consist of flooring, roofing, fireplace facings, mantels, and hearths. As well as, Architectural products, such as copings, facings panels, window sills, treads and risers, counter tops, and vanities.

Advantages:

- A variety of finishes are available.
- A variety of thicknesses are available.
- Durable
- Resistance to acids.
- Resistance to water penetration.
- All products are custom manufactured.

Disadvantages:

- Found to be cost prohibitive.
- Life expectancy is unknown.



P.O. Box 11498
Richmond, VA 23230
Phone: (800) 825-0717
Fax: (804) 285-0780

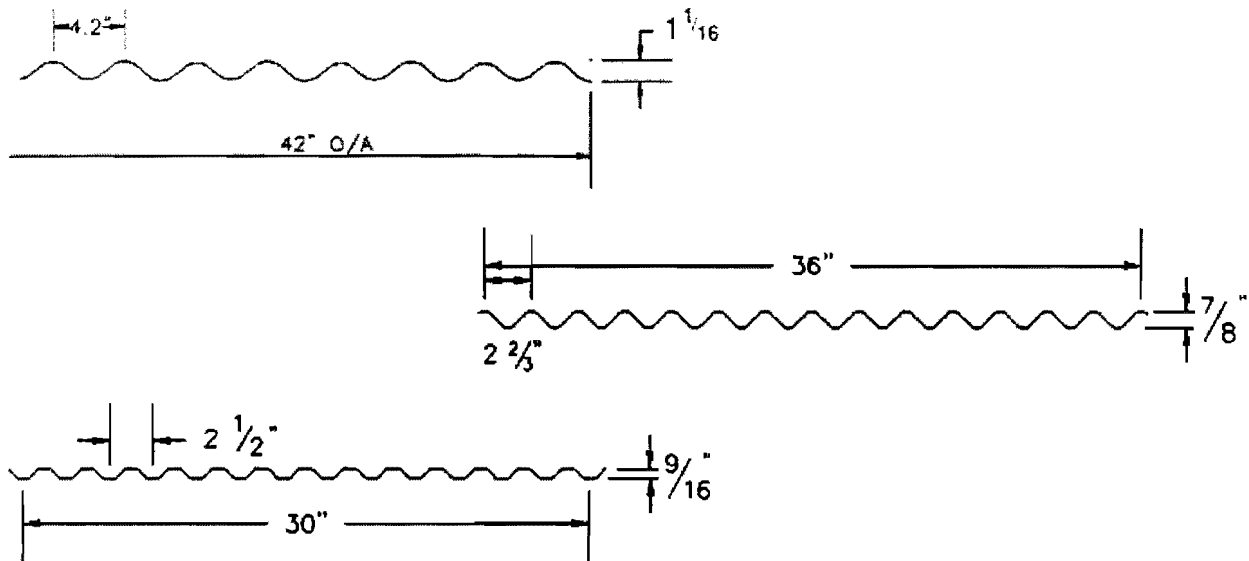

Material and Construction:

James River Steel cladding panels are available in stainless steel. Stainless steel is a corrosion resistant alloy steel that contains 10.5 % or more chromium. James River offers a large variety of panels. These panels come in a variety of metal compositions and formations.

Typical Applications:

James River Steel cladding panels can be used for roofing and siding. The panels can be overlapped and sealed to guarantee weatherproofing.

Advantages:

- Versatile
- Weather-tight seals
- Encourages ice and snow shedding
- Wide variety of panels

Disadvantages:

- Possibly cost prohibitive
- Possible weathering of panels
- Not very aesthetically pleasing

ALLIANCE

CERAMICSTEEL PRODUCTS



4888 South Old Peachtree Rd.
Norcross, GA 30071
Phone: (800) 631-4514
Fax: (770) 446-5951

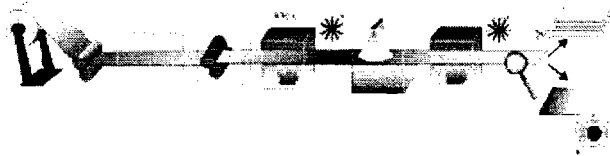
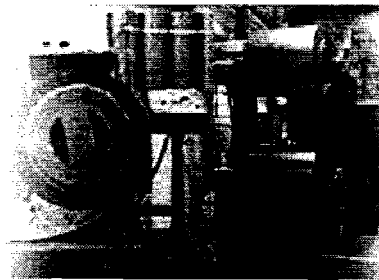

Material and Construction:

Ceramicsteel combines the strength of steel with the resistance of glass. Ceramicsteel is produced using a fusion process that applies a ceramic layer to steel in a continuous process at temperatures exceeding 800°. This fusion results in an extremely resistant material uniting the unique characteristics of both components while leaving out the negative characteristics. The steel is a special cold-forged steel which is low in carbon. The ceramic layer consists of quartz, feldspar, and other inorganic materials, which are ground together with metal oxides (for coloring purposes) and water.

Typical Applications:

Ceramicsteel is used in tunnel linings, clean rooms, and wall claddings for metros, stations, and airports.

Advantages:

- Strength of steel
- Resistance of glass
- Finest, most durable finish in the world
- Last without any sign of aging
- Scratch and impact resistance
- Imcombustibility
- Resistance to wear and color fade
- Can easily be cleaned, even after a professional graffiti treatment

Disadvantages:

- Found to be cost prohibitive.

ALTA GOLDBOARD

449 92nd Avenue Suite 1033
Edmonton, AB T6B 2V4
Phone: (403) 440-3320
Fax: (403) 440-3268

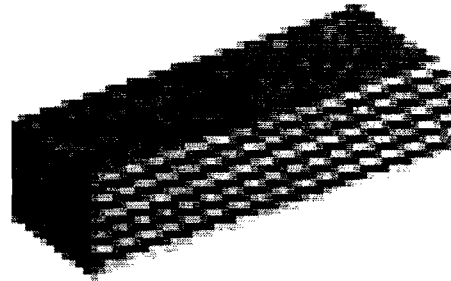
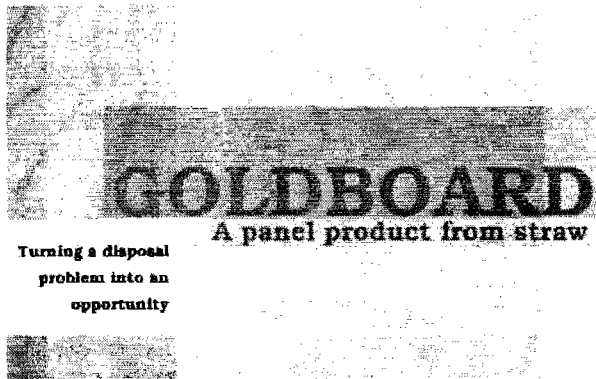

Material and Construction:

Goldboard is a straw-based panel. Alta Goldboard offers three different products: Goldboard, Goldboard Plus, and Goldboard Floor. Goldboard is a panel with performance similar to a premium-quality particleboard from wood yet with a tighter edge due to the fibrous nature of the furnish. Goldboard Plus is a panel with performance similar to standard-quality medium-density fibreboard from wood but with capability of interior and exterior applications. Goldboard Floor is a panel with a performance superior to any medium-density fibreboard from wood for that specific purpose.

Typical Applications:

Goldboard, Goldboard Plus, and Goldboard Floor are used in interior and exterior applications. Some examples of these are underlayment, mobile-home decking, exterior siding, high-stiffness shelving, exterior signage substrate, interior and exterior moldings, window trim, and framing.

Advantages:

- Strength of particleboard
- Dimensional stability
- Light weight

Disadvantages:

- Subject to weathering



Marketor International Corporation

P.O. Box 1721
Clackamas, Oregon 97015
Phone: (503) 650-4788
Fax: (503) 650-7221

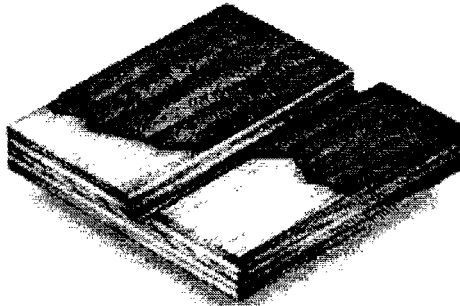

Material and Construction:

Simpson Guardian Siding gives you weather-tested durability and beauty in an easy to work with overlaid plywood siding panel. It is made of high quality, exterior grade plywood with a medium density overlay permanently fused to the face side. A woodgrain texture is embossed into the overlay during the bonding process.

Typical Applications:

Guardian Siding is specifically designed for use on single-family developments, multi-family projects, commercial structures, modular buildings, portable classrooms and light industrial structures.

Advantages:

- Light and easy to handle
- Weather-tested durability
- Economical
- Structurally strong and rigid
- Resists surface abuse

Disadvantages:

- Susceptible to shrinkage
- Susceptible to swelling in damp or rainy weather

BELLCOMB

TECHNOLOGIES INCORPORATED

70 North 22nd Avenue
Minneapolis, MN 55411
Phone: (612) 521-2425
Fax: (612) 521-2376

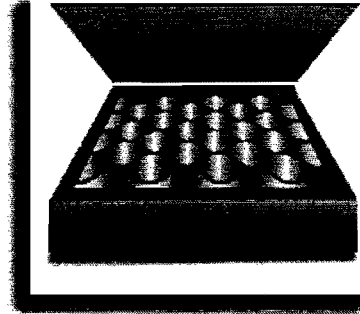
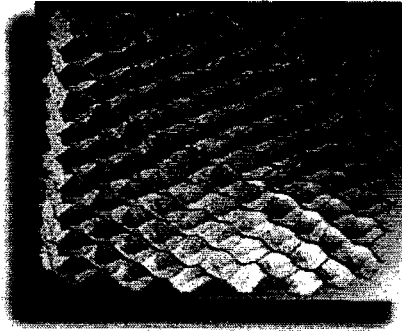

Material and Construction:

Bellcomb panels are composed of three parts: the core, the skin, and the frame. The core can be made of phenolic impregnated kraft honeycomb, aluminum honeycomb, urethane foam, balsa wood, extruded polystyrene, and expanded polyurethane. Skins can be made of aluminum, steel, stainless steel, fiberglass, plastic laminate, hardboard, plywood, ABS, kydex, polyethylene, lauan, and paper. Frames can be made of aluminum extrusion, roll formed steel and aluminum, manufactured wood, hardwoods, fiberglass pultrusion, and solid and formed plastics. Panels are available in a wide variety of sizes. Though to date the smallest panel produced was 9.25" x 10" x 0.120" and the largest, 5' x 16' x 6.4".

Typical Applications:

Bellcomb Technologies Incorporated designs and produces structural lightweight panels and panel systems for a wide range of applications. Most of the products are used as components of other products. Some examples of applications are the trading floor at the Chicago Board of Trade, telecommunications vault covers, and stage decks. Other applications include over the road truck cabinetry, x-ray photographic plates, clean room walls, laser tag arena partition walls, dance floors, museum exhibit panels, trade show display panels, and desks and other office furniture.

Advantages:

- Lightweight
- Varied skin surfaces
- Strong strength-to-weight ratio
- Nearly impossible for the panel to expand or contract in atmospheric conditions
- High compressive strength
- Can either reflect or absorb sound
- Water resistant
- Fire resistant
- Thermal efficiency

Disadvantages:

- Found to be cost prohibitive.

Stone panels Inc.



1725 Sandy Lake Road
Carrollton, TX 75006
Phone: (972) 446-1776 / (800) 328-6275
Fax: (972) 245-3749 / (800) 752-0783

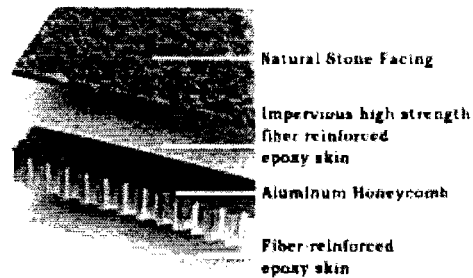
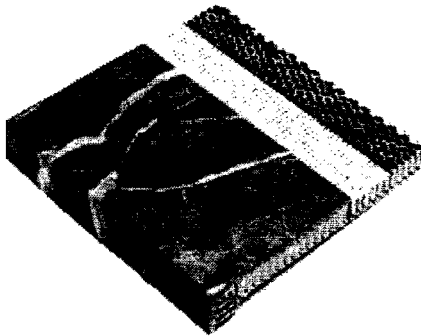

Material and Construction:

Stone Panels are created by natural stone veneer bonded by high strength glass fiber reinforced epoxy skin to aluminum honeycomb reinforcing. Marbles, granites, limestones, sandstones and Dolomites are all available for the natural stone veneer.

Typical Applications:

Stone Panels are ment to be used as an exterior commercial covering. Typical applications are for the coverings of commercial buildings. Some examples include the exterior of the Silver Star Resort and Casino in Philadelphia, Mississippi and the Nesbett Courthouse in Anchorage, Alaska.

Advantages:

- Unlimited variety of natural stone facings.
- Weighs 80 percent less than solid stone.
- Impact strength more than 60 times greater than 3 cm granite.
- Tested to over 400 psf wind load capacity.
- Stability, provided by honeycomb panels and stress-relieved stone, eliminates warpage.
- Fully tested for acid freeze-thaw and seismic racking.
- High flexural strength allows larger panels, greater attachment spacing and high wind load capacities.
- Impervious to water penetration.
- Proven performance in all climates.

Disadvantages:

- Found to be cost prohibitive.
- Load capacity can be limited by fastener spacing.



P.O. Box 300
Midland, VA 22728
Phone: (540) 439-3266
Fax: (540) 439-1232

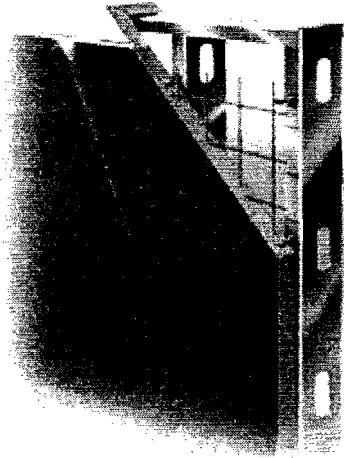

SPANDREL PANELS

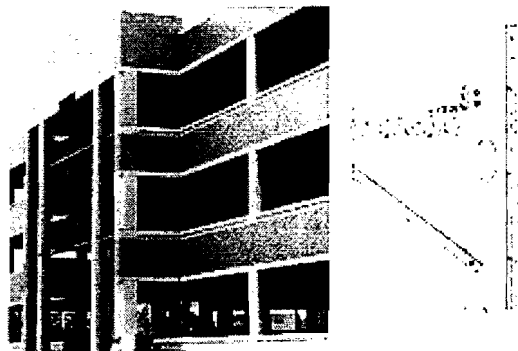

Material and Construction:

Slenderwall is a precast concrete paneling system. Slenderwall is the only wall system that combines these proven components: architectural precast concrete, thermaguard, and light-gauge steel studs engineered into a single efficient wall system. Thermaguard is an insulator/isolator epoxy coated steel connecting anchor that insulates from heat and cold. Slenderwall is designed to isolate the exterior precast concrete skin from the structural stresses associated with wind loading, steel frame movement, expansion and contraction, and seismic shock.

Typical Applications:

Slenderwall is typically used for the exterior paneling of commercial buildings. It is designed for new construction and recladding projects.

Advantages:

- Allows the building frame to move independently of the exterior skin, preserving structural integrity
- Water tight
- Prevents corrosion
- Resists alkali reactions
- Reduces thermal transfer
- Unlimited design freedom
- Unmatched product life

Disadvantages:

- Found to be cost prohibitive

NIDA-CORE

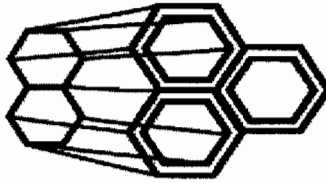

3240 SW 42nd Avenue
Palm City, FL 34900
Phone: (561) 287-6464
Fax: (561) 287-5373

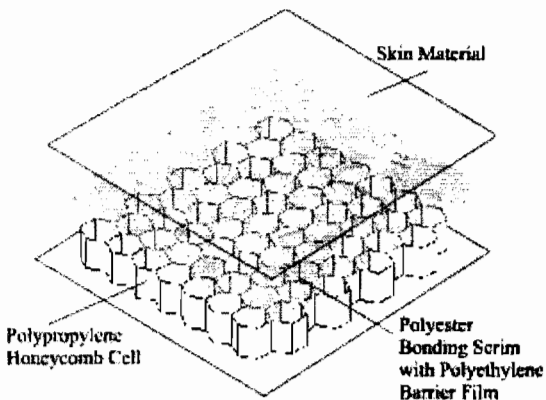

Material and Construction:

Nida-core is an extruded polypropylene honeycomb used as a light weight core in sandwich composite panels. The polypropylene honeycomb as available in different thicknesses (3/16 inch to 18 inch), different diameter cells (8mm or 20mm = 1/3" or 3/4"), and features a non-woven polyester scrim thermofused to each of its core faces. This polyester scrim provides superior bonding properties and peel strength. In addition, a polyethylene film is fused between the non-woven scrim and the polypropylene honeycomb in order to minimize resin migration to the cells. The typical panel size is 7' x 4' and comes with the option of having the honeycomb filled with either urethane foam or phenolic foam.

Typical Applications:

Nida-core is widely used in various applications in the marine, architecture, transportation, auto racing, civil engineering, and military fields.

Advantages:

- High strength to weight ratio
- Light weight sound insulating
- Absorbs and dissipates impact and cyclic loading
- Rot proof
- Resistant to most chemical agents
- Fire insulation
- Bonds to a wide variety of skin materials

Disadvantages:

- Found to be cost prohibitive.